

# Drawing UML with PlantUML

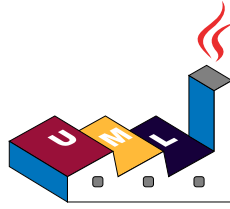

## Language Reference Guide (Version 8023)

**PlantUML** is an Open Source project that allows to quickly write:

- Sequence diagram,
- Usecase diagram,
- Class diagram,
- Activity diagram,
- Component diagram,
- State diagram,
- Object diagram.

Diagrams are defined using a simple and intuitive language.

# 1 Sequence Diagram

## 1.1 Basic examples

The sequence "`->`" is used to draw a message between two participants. Participants do not have to be explicitly declared.

To have a dotted arrow, you use `-->`

It is also possible to use `<-` and `<--`. That does not change the drawing, but may improve readability.

```
@startuml
Alice -> Bob: Authentication Request
Bob --> Alice: Authentication Response

Alice -> Bob: Another authentication Request
Alice <-- Bob: another authentication Response
@enduml
```

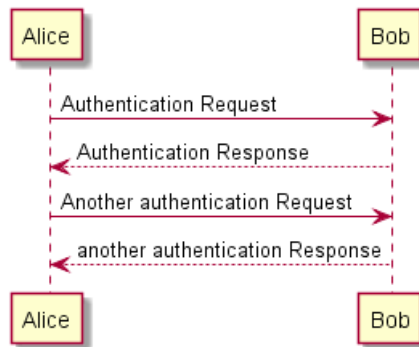

## 1.2 Comments

Everything that starts with `simple quote ' is a comment.`

You can also put comments on several lines using `/' to start and '/ to end.`

## 1.3 Declaring participant

It is possible to change participant order using the `participant` keyword.

It is also possible to use other keywords to declare a participant:

- actor
- boundary
- control
- entity
- database

```
@startuml
actor Foo1
boundary Foo2
control Foo3
entity Foo4
database Foo5
Foo1 -> Foo2 : To boundary
Foo1 -> Foo3 : To control
Foo1 -> Foo4 : To entity
Foo1 -> Foo5 : To database
@enduml
```

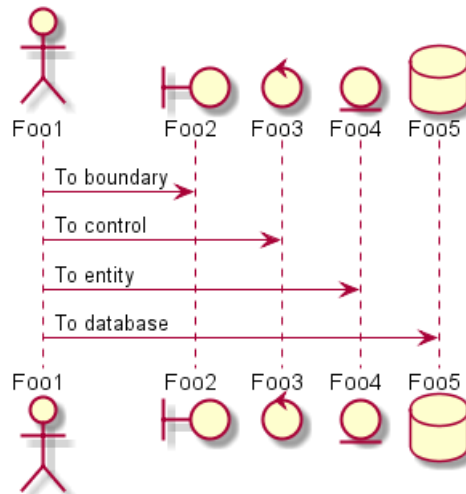

You can rename a participant using the `as` keyword.

You can also change the background color of actor or participant.

```
@startuml
actor Bob #red
' The only difference between actor
'and participant is the drawing
participant Alice
participant "I have a really\nlong name" as L #99FF99
/' You can also declare:
participant L as "I have a really\nlong name" #99FF99
'/
```

```
Alice->Bob: Authentication Request
Bob->Alice: Authentication Response
Bob->L: Log transaction
@enduml
```

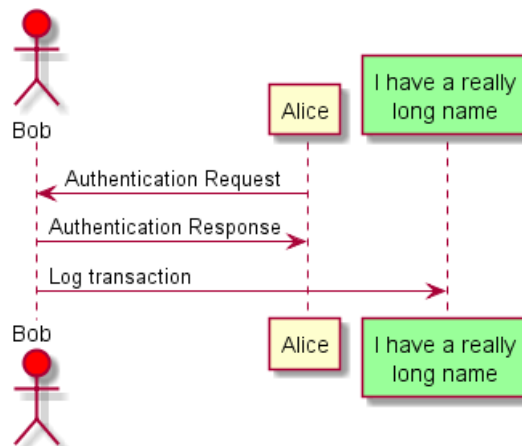

## 1.4 Use non-letters in participants

You can use quotes to define participants. And you can use the `as` keyword to give an alias to those participants.

```
@startuml
Alice -> "Bob()" : Hello
"Bob()" -> "This is very\nlong" as Long
' You can also declare:
' "Bob()" -> Long as "This is very\nlong"
Long --> "Bob()" : ok
@enduml
```

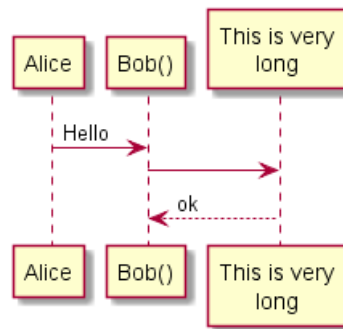

## 1.5 Message to Self

A participant can send a message to itself.

It is also possible to have multi-line using `\n`.

```

@startuml
Alice->Alice: This is a signal to self.\nIt also demonstrates\nmultiline \ntext
@enduml
  
```

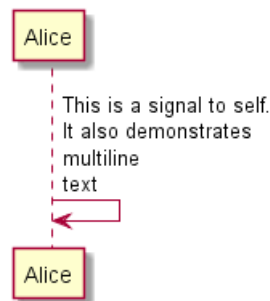

## 1.6 Change arrow style

You can change arrow style by several ways:

- add a final `x` to denote a lost message
- use `\` or `/` instead of `<` or `>` to have only the bottom or top part of the arrow
- repeat the arrow head (for example, `>>` or `//`) head to have a thin drawing
- use `--` instead of `-` to have a dotted arrow
- add a final `o` at arrow head
- use bidirectional arrow

```

@startuml
Bob ->x Alice
Bob -> Alice
Bob ->> Alice
Bob -\ Alice
Bob \\- Alice
Bob //-- Alice

Bob ->o Alice
Bob o\\-- Alice

Bob <-> Alice
Bob <->o Alice
@enduml
  
```

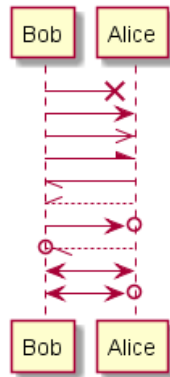

## 1.7 Change arrow color

You can change the color of individual arrows using the following notation:

```
@startuml
Bob -[#red]> Alice : hello
Alice -[#0000FF]->Bob : ok
@enduml
```

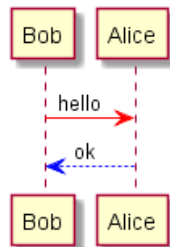

## 1.8 Message sequence numbering

The keyword `autonumber` is used to automatically add number to messages.

```
@startuml
autonumber
Bob -> Alice : Authentication Request
Bob <- Alice : Authentication Response
@enduml
```



You can specify a startnumber with `autonumber 'start'`, and also an increment with `autonumber 'start' 'increment'`.

```
@startuml
autonumber
Bob -> Alice : Authentication Request
Bob <- Alice : Authentication Response

autonumber 15
Bob -> Alice : Another authentication Request
Bob <- Alice : Another authentication Response

autonumber 40 10
```

```

Bob -> Alice : Yet another authentication Request
Bob <- Alice : Yet another authentication Response

@enduml

```

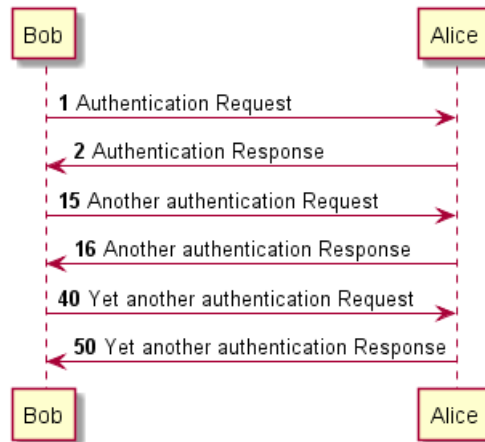

You can specify a format for your number by using between double-quote.

The formatting is done with the Java class `DecimalFormat` ('0' means digit, '#' means digit and zero if absent).

You can use some html tag in the format.

```

@startuml
autonumber "<b>[000]"
Bob -> Alice : Authentication Request
Bob <- Alice : Authentication Response

autonumber 15 "<b>(<u>##</u>)"
Bob -> Alice : Another authentication Request
Bob <- Alice : Another authentication Response

autonumber 40 10 "<font color=red><b>Message 0 "
Bob -> Alice : Yet another authentication Request
Bob <- Alice : Yet another authentication Response

@enduml

```

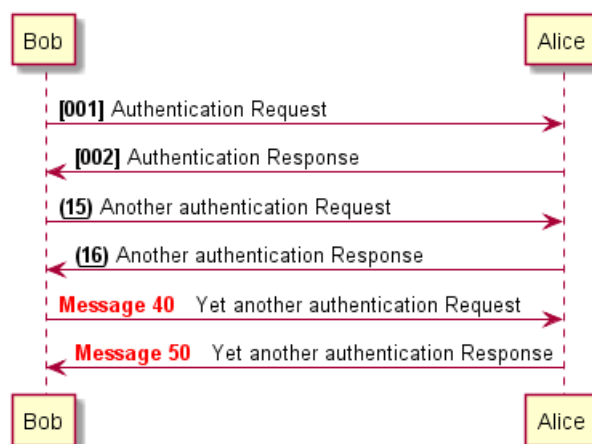

## 1.9 Title

The `title` keywords is used to put a title.

```

@startuml

title Simple communication example

```

```

Alice -> Bob: Authentication Request
Bob --> Alice: Authentication Response

@enduml

```

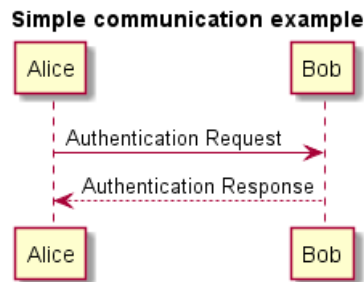

## 1.10 Legend the diagram

The `legend` and `end legend` are keywords is used to put a legend.

You can optionally specify to have `left`, `right` or `center` alignment for the legend.

```

@startuml

Alice -> Bob : Hello
legend right
Short
legend
endlegend

@enduml

```

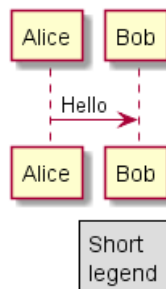

## 1.11 Splitting diagrams

The `newpage` keyword is used to split a diagram into several images.

You can put a title for the new page just after the `newpage` keyword.

This is very handy with *Word* to print long diagram on several pages.

```

@startuml

Alice -> Bob : message 1
Alice -> Bob : message 2

newpage

Alice -> Bob : message 3
Alice -> Bob : message 4

newpage A title for the\nlast page

Alice -> Bob : message 5
Alice -> Bob : message 6

@enduml

```

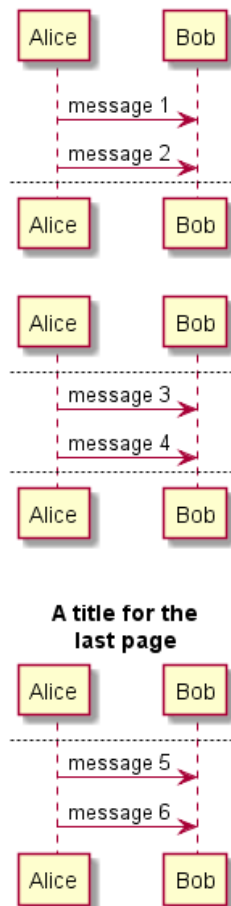

## 1.12 Grouping message

It is possible to group messages together using the following keywords:

- alt/else
- opt
- loop
- par
- break
- critical
- group, followed by a text to be displayed

It is possible to add a text that will be displayed into the header (except for `group`).

The `end` keyword is used to close the group.

Note that it is possible to nest groups.

```

@startuml
Alice -> Bob: Authentication Request

alt successful case
Bob -> Alice: Authentication Accepted

else some kind of failure
Bob -> Alice: Authentication Failure
group My own label
Alice -> Log : Log attack start
loop 1000 times
  
```



```

Alice -> Bob: DNS Attack
end
Alice -> Log : Log attack end
end

else Another type of failure

Bob -> Alice: Please repeat

end
@enduml

```

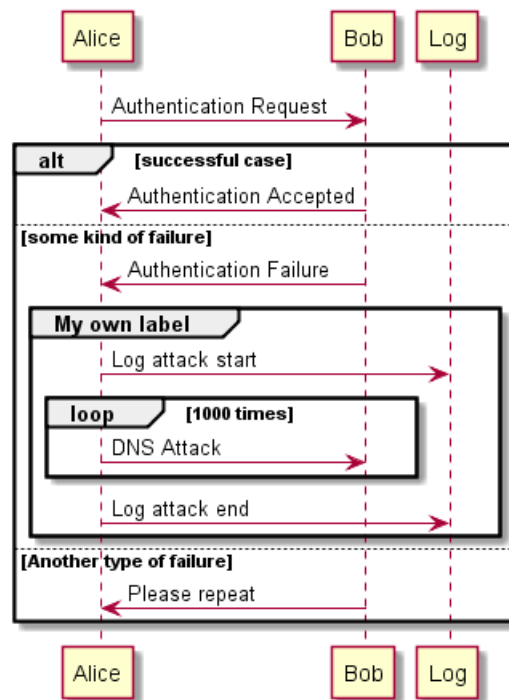

### 1.13 Notes on messages

It is possible to put notes on message using the `note left` or `note right` keywords *just after the message*. You can have a multi-line note using the `end note` keywords.

```

@startuml
Alice->Bob : hello
note left: this is a first note

Bob->Alice : ok
note right: this is another note

Bob->Bob : I am thinking
note left
a note
can also be defined
on several lines
end note
@enduml

```

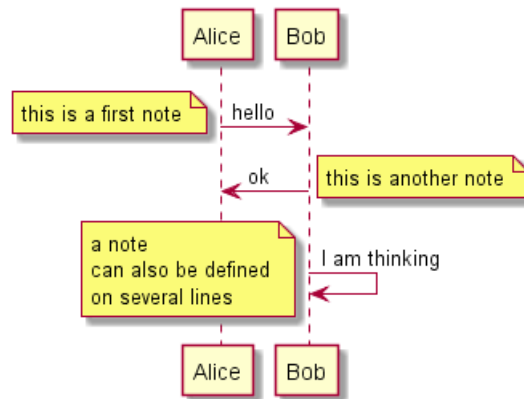

## 1.14 Some other notes

It is also possible to place notes relative to participant with `note left of`, `note right of` or `note over` keywords.

It is possible to highlight a note by changing its background color.

You can also have a multi-line note using the `end note` keywords.

```

@startuml
participant Alice
participant Bob
note left of Alice #aqua
This is displayed
left of Alice.
end note

note right of Alice: This is displayed right of Alice.

note over Alice: This is displayed over Alice.

note over Alice, Bob #FFAAAA: This is displayed\n over Bob and Alice.

note over Bob, Alice
This is yet another
example of
a long note.
end note
@enduml
  
```

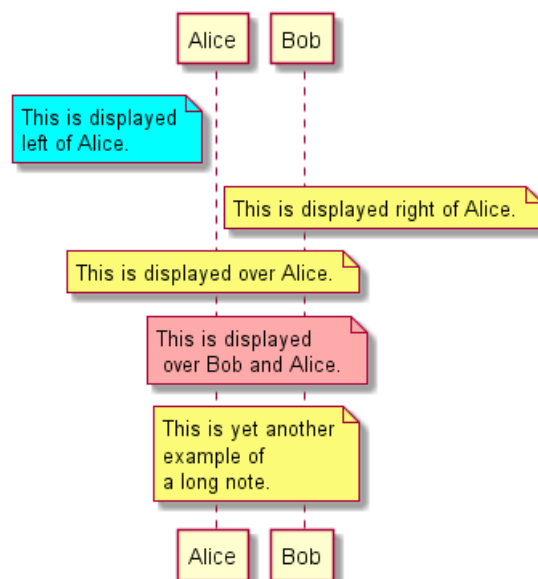

## 1.15 Changing notes shape

You can use `hnote` and `rnote` keywords to change note shapes.

```
@startuml
caller -> server : conReq
hnote over caller : idle
caller <- server : conConf
rnote over server
"r" as rectangle
"h" as hexagon
endnote
@enduml
```

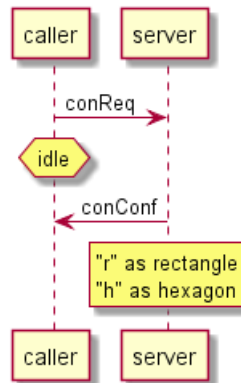

## 1.16 Creole and HTML

It is also possible to use creole formatting:

```
@startuml
participant Alice
participant "The Famous Bob" as Bob

Alice -> Bob : hello --there--
... Some ~long delay~ ...
Bob -> Alice : ok
note left
This is bold
This is italics
This is "monospaced"
This is --stroked--
This is underlined
This is ~waved~
end note

Alice -> Bob : A //well formatted// message
note right of Alice
This is <back:cadetblue><size:18>displayed</size></back>
__left of__ Alice.
end note
note left of Bob
<u:red>This</u> is <color #118888>displayed</color>
**<color purple>left of</color> <s:red>Alice</strike> Bob**.
end note
note over Alice, Bob
<w:#FF33FF>This is hosted</w> by <img sourceforge.jpg>
end note
@enduml
```

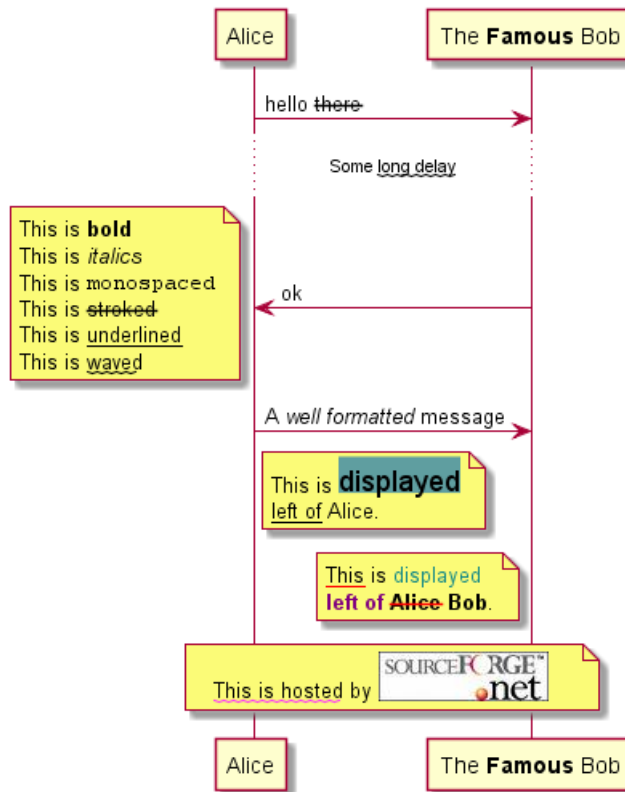

### 1.17 Divider

If you want, you can split a diagram using == separator to divide your diagram into logical steps.

```

@startuml
== Initialization ==
Alice -> Bob: Authentication Request
Bob --> Alice: Authentication Response
== Repetition ==
Alice -> Bob: Another authentication Request
Alice <-- Bob: another authentication Response
@enduml
    
```

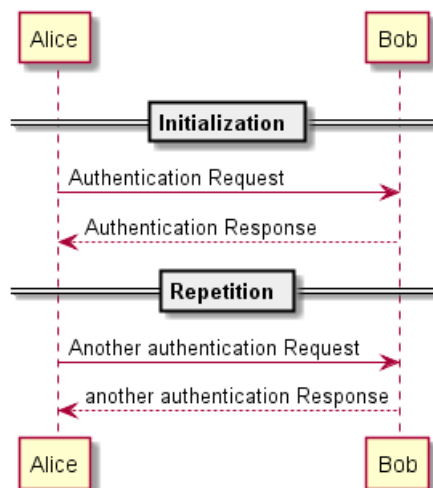

## 1.18 Reference

You can use reference in a diagram, using the keyword `ref` over.

```
@startuml
participant Alice
actor Bob

ref over Alice, Bob : init

Alice -> Bob : hello

ref over Bob
This can be on
several lines
end ref
@enduml
```

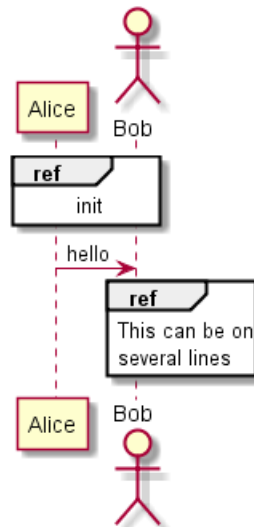

## 1.19 Delay

You can use `...` to indicate a delay in the diagram. And it is also possible to put a message with this delay.

```
@startuml
Alice -> Bob: Authentication Request
...
Bob --> Alice: Authentication Response
...5 minutes latter...
Bob --> Alice: Bye !
@enduml
```

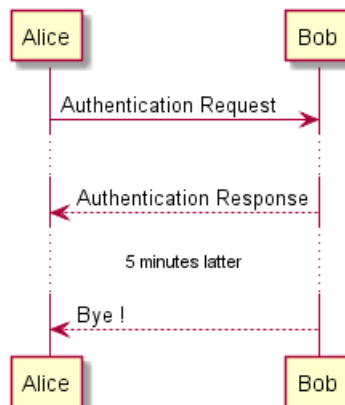

## 1.20 Space

You can use `|||` to indicate some spacing in the diagram.

It is also possible to specify a number of pixel to be used.

```
@startuml
Alice -> Bob: message 1
Bob --> Alice: ok
|||
Alice -> Bob: message 2
Bob --> Alice: ok
||45||
Alice -> Bob: message 3
Bob --> Alice: ok
@enduml
```

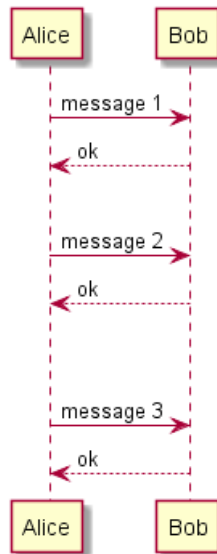

## 1.21 Lifeline Activation and Destruction

The `activate` and `deactivate` are used to denote participant activation.

Once a participant is activated, its lifeline appears.

The `activate` and `deactivate` apply on the previous message.

The `destroy` denote the end of the lifeline of a participant.

```
@startuml
participant User
User -> A: DoWork
activate A
A -> B: << createRequest >>
activate B
B -> C: DoWork
activate C
C --> B: WorkDone
destroy C
B --> A: RequestCreated
deactivate B
A -> User: Done
deactivate A
@enduml
```

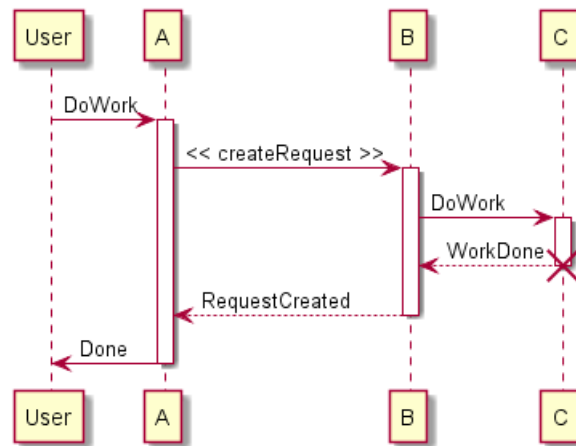

Nested lifeline can be used, and it is possible to add a color on the lifeline.

```

@startuml
participant User

User -> A: DoWork
activate A #FFBBBB

A -> A: Internal call
activate A #DarkSalmon

A -> B: << createRequest >>
activate B

B --> A: RequestCreated
deactivate B
deactivate A
A -> User: Done
deactivate A

@enduml
  
```

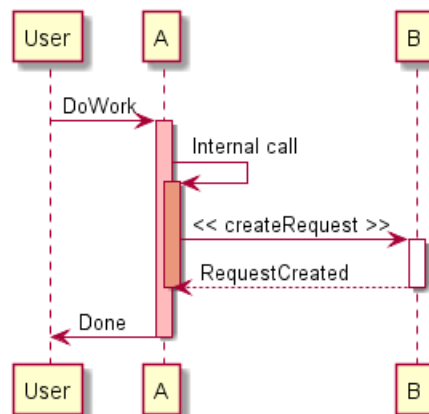

## 1.22 Participant creation

You can use the `create` keyword just before the first reception of a message to emphasize the fact that this message is actually *creating* this new object.

```

@startuml
Bob -> Alice : hello

create Other
Alice -> Other : new

create control String
Alice -> String
  
```

```

note right : You can also put notes!
Alice --> Bob : ok
@enduml

```

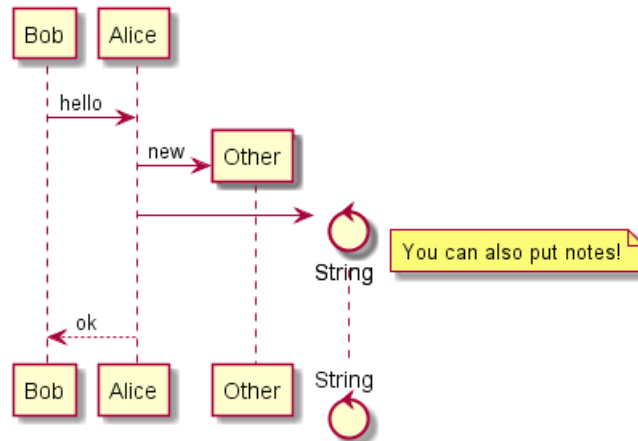

### 1.23 Incoming and outgoing messages

You can use incoming or outgoing arrows if you want to focus on a part of the diagram.

Use square brackets to denote the left "[" or the right "]" side of the diagram.

```

@startuml
[-> A: DoWork

activate A

A -> A: Internal call
activate A

A ->] : << createRequest >>

A<--] : RequestCreated
deactivate A
[<- A: Done
deactivate A
@enduml

```

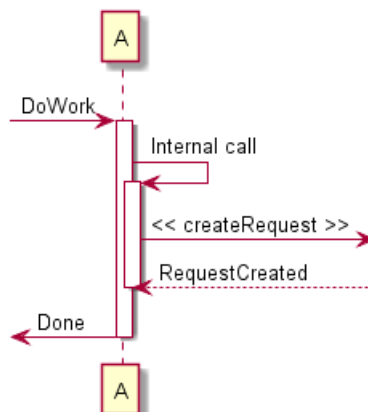

You can also have the following syntax:

```

@startuml
[-> Bob
[o-> Bob
[o->o Bob
[x-> Bob

```



```

[<- Bob
[x<- Bob

Bob ->]
Bob ->o]
Bob o->o]
Bob ->x]

Bob <-]
Bob x<-]
@enduml

```



## 1.24 Stereotypes and Spots

It is possible to add stereotypes to participants using << and >>.

In the stereotype, you can add a spotted character in a colored circle using the syntax (X,color).

```

@startuml

participant "Famous Bob" as Bob << Generated >>
participant Alice << (C,#ADD1B2) Testable >>

Bob->Alice: First message

@enduml

```

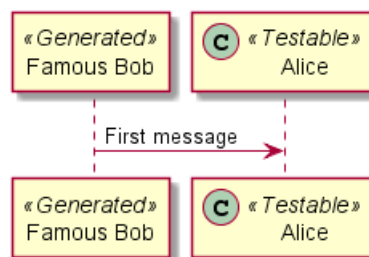

By default, the *guillemet* character is used to display the stereotype. You can change this behaviour using the skinparam *guillemet*:

```

@startuml

skinparam guillemet false
participant "Famous Bob" as Bob << Generated >>
participant Alice << (C,#ADD1B2) Testable >>

Bob->Alice: First message

@enduml

```

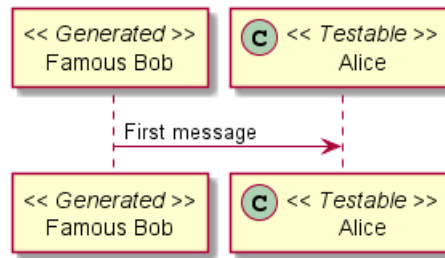

```

@startuml
participant Bob << (C,#ADD1B2) >>
participant Alice << (C,#ADD1B2) >>

Bob->>Alice: First message
@enduml

```

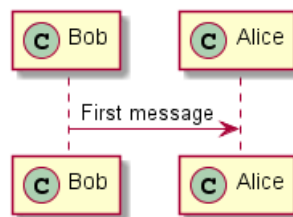

## 1.25 More information on titles

You can use creole formatting in the title.

```

@startuml
title __Simple__ communication example

Alice -> Bob: Authentication Request
Bob -> Alice: Authentication Response

@enduml

```

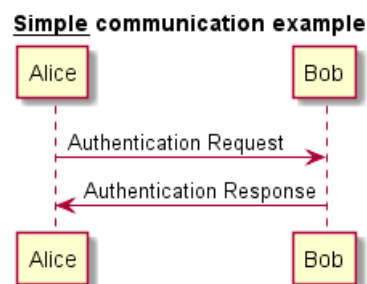

You can add newline using \n in the title description.

```

@startuml
title __Simple__ communication example\nnon several lines

Alice -> Bob: Authentication Request
Bob -> Alice: Authentication Response

@enduml

```

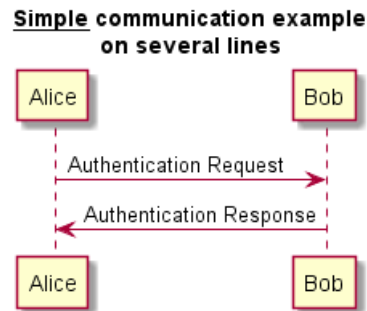

You can also define title on several lines using `title` and `end title` keywords.

```

@startuml

title
<u>Simple</u> communication example
on <i>several</i> lines and using <font color=red>html</font>
This is hosted by <img:sourceforge.jpg>
end title

Alice -> Bob: Authentication Request
Bob -> Alice: Authentication Response

@enduml
  
```

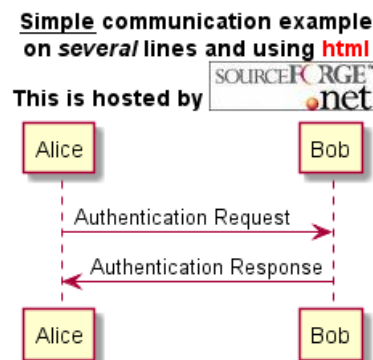

## 1.26 Participants encompass

It is possible to draw a box around some participants, using `box` and `end box` commands.

You can add an optional title or a optional background color, after the `box` keyword.

```

@startuml

box "Internal Service" #LightBlue
participant Bob
participant Alice
end box
participant Other

Bob -> Alice : hello
Alice -> Other : hello

@enduml
  
```

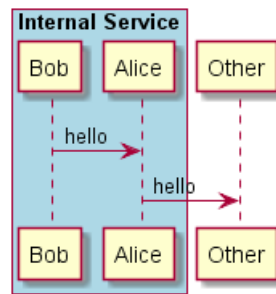

## 1.27 Removing Footer

You can use the `hide footbox` keywords to remove the footer of the diagram.

```

@startuml

hide footbox
title Footer removed

Alice -> Bob: Authentication Request
Bob --> Alice: Authentication Response

@enduml
  
```

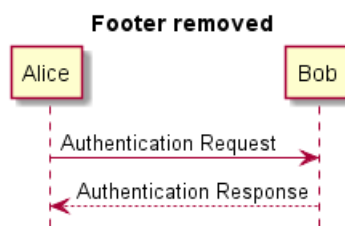

## 1.28 Skinparam

You can use the `skinparam` command to change colors and fonts for the drawing.

You can use this command:

- In the diagram definition, like any other commands,
- In an included file,
- In a configuration file, provided in the command line or the ANT task.

```

@startuml
skinparam backgroundColor #EEEEBC

skinparam sequence {
ArrowColor DeepSkyBlue
ActorBorderColor DeepSkyBlue
LifeLineBorderColor blue
LifeLineBackgroundColor #A9DCDF

ParticipantBorderColor DeepSkyBlue
ParticipantBackgroundColor DodgerBlue
ParticipantFontName Impact
ParticipantFontSize 17
ParticipantFontColor #A9DCDF

ActorBackgroundColor aqua
ActorFontColor DeepSkyBlue
ActorFontSize 17
ActorFontName Aapex
}
  
```

```
actor User
participant "First Class" as A
participant "Second Class" as B
participant "Last Class" as C

User -> A: DoWork
activate A

A -> B: Create Request
activate B

B -> C: DoWork
activate C
C --> B: WorkDone
destroy C

B --> A: Request Created
deactivate B

A --> User: Done
deactivate A

@enduml
```

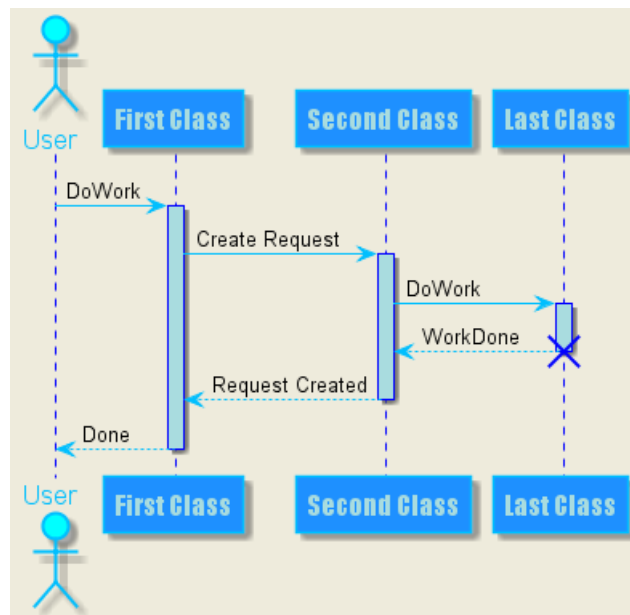

## 2 Use Case Diagram

### 2.1 Usecases

Use cases are enclosed using between parentheses (because two parentheses looks like an oval).

You can also use the `usecase` keyword to define a usecase. And you can define an alias, using the `as` keyword. This alias will be used latter, when defining relations.

```
@startuml
(First usecase)
(Another usecase) as (UC2)
usecase UC3
usecase (Last\nusecase) as UC4
@enduml
```

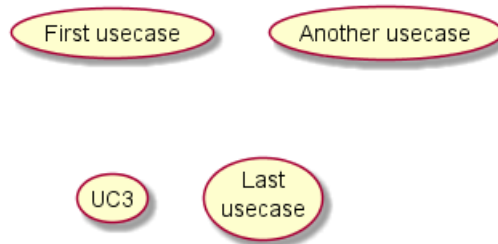

### 2.2 Actors

Actor are enclosed using between two points.

You can also use the `actor` keyword to define an actor. And you can define an alias, using the `as` keyword. This alias will be used latter, when defining relations.

We will see later that the actor definitions are optional.

```
@startuml
:First Actor:
:Another\nactor: as Men2
actor Men3
actor :Last actor: as Men4
@enduml
```

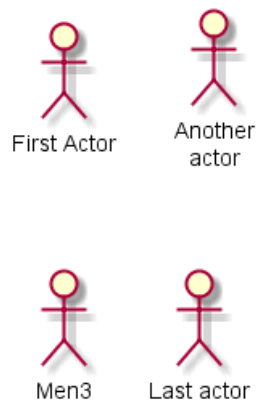

### 2.3 Usecases description

If you want to have description on several lines, you can use quotes.

You can also use the following separators: `--` `..` `==` `__`. And you can put titles within the separators.

```

@startuml
usecase UC1 as "You can use
several lines to define your usecase.
You can also use separators.
--
Several separators are possible.
==
And you can add titles:
..Conclusion..
This allows large description."
@enduml

```

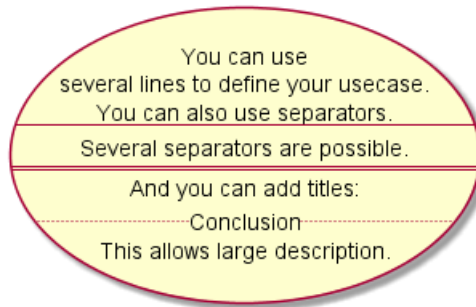

## 2.4 Basic example

To link actors and use cases, the arrow --> is used.

The more dashes "-" in the arrow, the longer the arrow. You can add a label on the arrow, by adding a ":" character in the arrow definition.

In this example, you see that *User* has not been defined before, and is used as an actor.

```

@startuml
User -> (Start)
User --> (Use the application) : A small label
:Main Admin: ---> (Use the application) : This is\nyet another\nlabel
@enduml

```

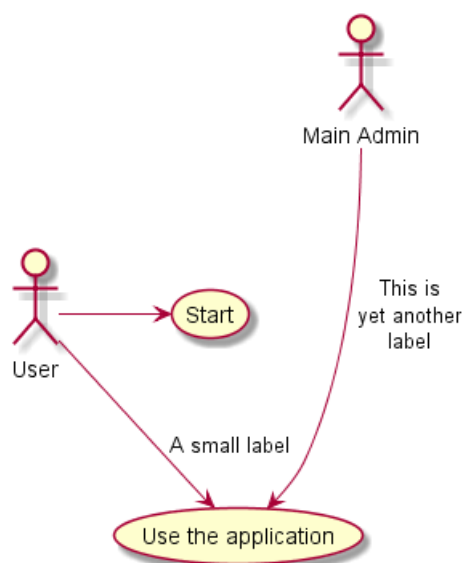

## 2.5 Extension

If one actor/use case extends another one, you can use the symbol <|-- (which stands for )

```
@startuml
:Main Admin: as Admin
(Use the application) as (Use)

User <|-- Admin
(Start) <|-- (Use)

@enduml
```

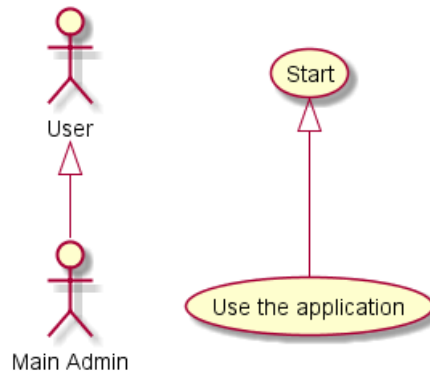

## 2.6 Using notes

You can use the note left of , note right of , note top of , note bottom of keywords to define notes related to a single object.

A note can be also define alone with the note keywords, then linked to other objects using the .. symbol.

```
@startuml
:Main Admin: as Admin
(Use the application) as (Use)

User -> (Start)
User --> (Use)

Admin ---> (Use)

note right of Admin : This is an example.

note right of (Use)
A note can also
be on several lines
end note

note "This note is connected\nto several objects." as N2
(Start) .. N2
N2 .. (Use)

@enduml
```



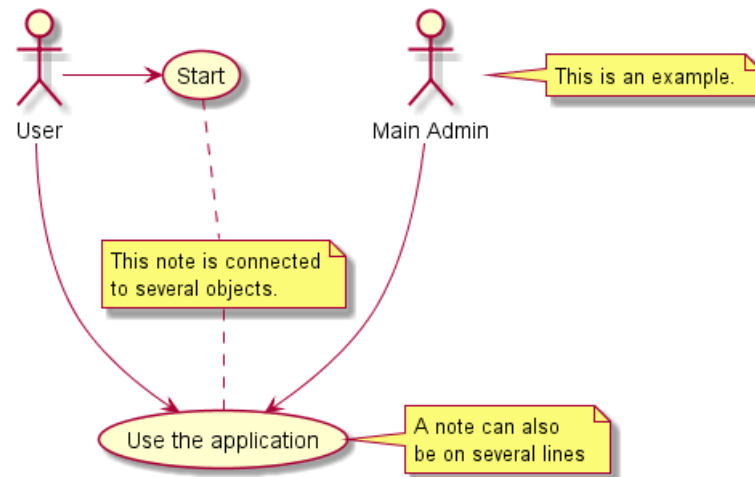

## 2.7 Stereotypes

You can add stereotypes while defining actors and use cases using " << " and " >> ".

```
@startuml
User << Human >>
:Main Database: as MySQL << Application >>
(Start) << One Shot >>
(Use the application) as (Use) << Main >>

User -> (Start)
User --> (Use)

MySQL --> (Use)

@enduml
```

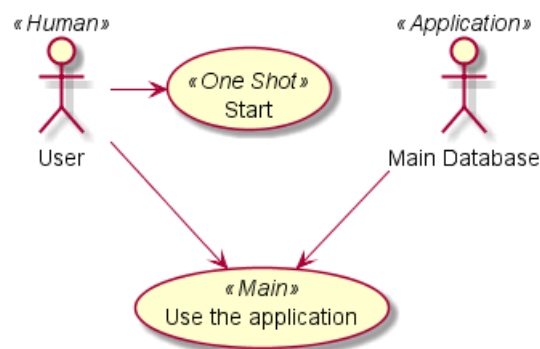

## 2.8 Changing arrows direction

By default, links between classes have two dashes -- and are vertically oriented. It is possible to use horizontal link by putting a single dash (or dot) like this:

```
@startuml
:user: --> (Use case 1)
:user: -> (Use case 2)
@enduml
```

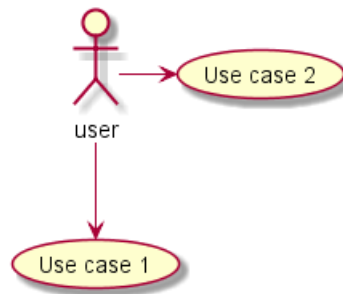

You can also change directions by reversing the link:

```
@startuml
(Use case 1) <.. :user:
(Use case 2) <- :user:
@enduml
```

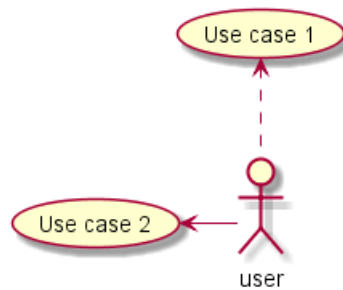

It is also possible to change arrow direction by adding `left`, `right`, `up` or `down` keywords inside the arrow:

```
@startuml
:user: -left-> (dummyLeft)
:user: -right-> (dummyRight)
:user: -up-> (dummyUp)
:user: -down-> (dummyDown)
@enduml
```

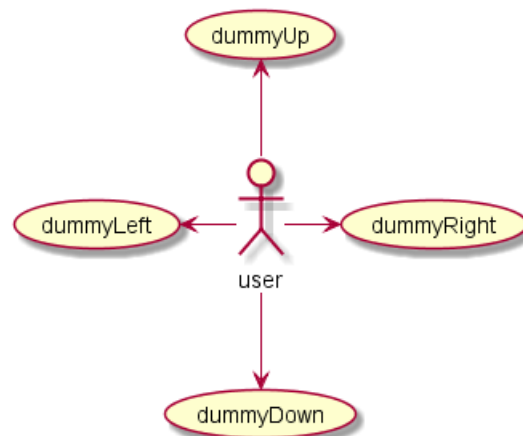

You can shorten the arrow by using only the first character of the direction (for example, `-d-` instead of `-down-`) or the two first characters (`-do-`).

Please note that you should not abuse this functionality : *Graphviz* gives usually good results without tweaking.

## 2.9 Title the diagram

The `title` keywords is used to put a title.

You can use `title` and `end title` keywords for a longer title, as in sequence diagrams.

```
@startuml
title Simple <b>Usecase</b>\nwith one actor

"Use the application" as (Use)
User -> (Use)

@enduml
```

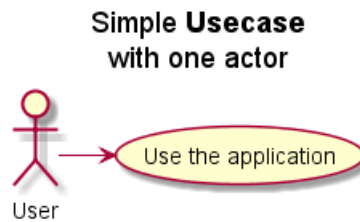

## 2.10 Splitting diagrams

The `newpage` keywords to split your diagram into several pages or images.

```
@startuml
:actor1: --> (Usecase1)
newpage
:actor2: --> (Usecase2)
@enduml
```

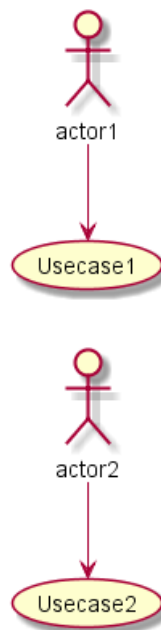

## 2.11 Left to right direction

The general default behavior when building diagram is **top to bottom**.

```
@startuml
'default
top to bottom direction
user1 --> (Usecase 1)
user2 --> (Usecase 2)

@enduml
```

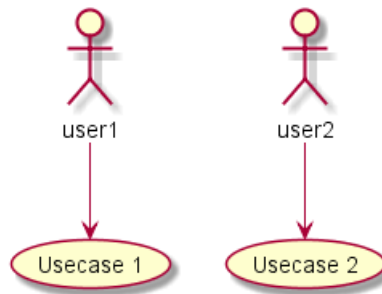

You may change to **left to right** using the `left to right direction` command. The result is often better with this direction.

```
@startuml
```

```
left to right direction
```

```
user1 --> (Usecase 1)
```

```
user2 --> (Usecase 2)
```

```
@enduml
```

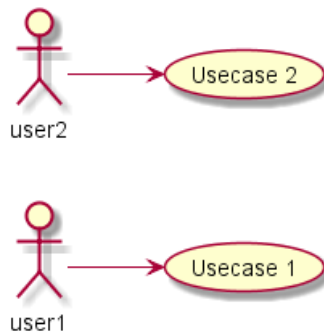

## 2.12 Skinparam

You can use the `skinparam` command to change colors and fonts for the drawing.

You can use this command :

- In the diagram definition, like any other commands,
- In an included file,
- In a configuration file, provided in the command line or the ANT task.

You can define specific color and fonts for stereotyped actors and usecases.

```
@startuml
```

```
skinparam handwritten true
```

```
skinparam usecase {
```

```
BackgroundColor DarkSeaGreen
```

```
BorderColor DarkSlateGray
```

```
BackgroundColor<< Main >> YellowGreen
```

```
BorderColor<< Main >> YellowGreen
```

```
ArrowColor Olive
```

```
ActorBorderColor black
```

```
ActorFontName Courier
```

```
ActorBackgroundColor<< Human >> Gold
```

```
}
```

```
User << Human >>
```

```
:Main Database: as MySql << Application >>
```



```

(Start) << One Shot >>
(Use the application) as (Use) << Main >>

User -> (Start)
User --> (Use)

MySQL --> (Use)

@enduml

```

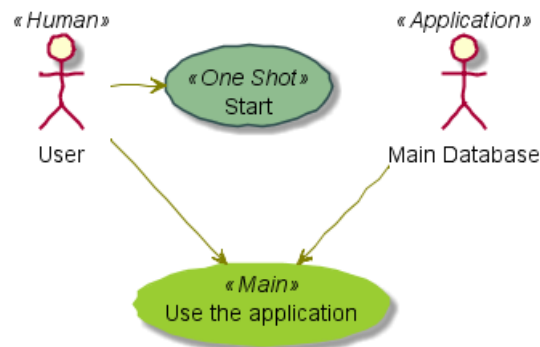

## 2.13 Complete example

```

@startuml
left to right direction
skinparam packageStyle rect
actor customer
actor clerk
rectangle checkout {
customer -- (checkout)
(checkout) .> (payment) : include
(help) .> (checkout) : extends
(checkout) -- clerk
}
@enduml

```

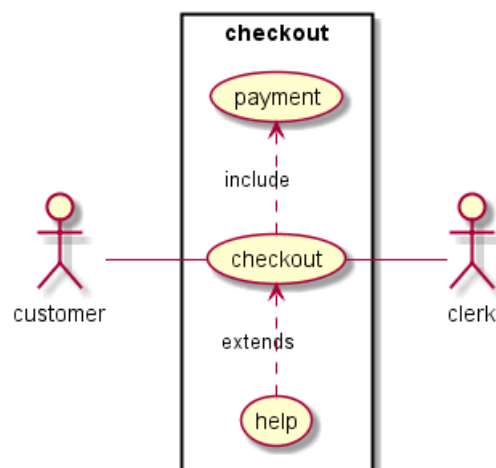

## 3 Class Diagram

### 3.1 Relations between classes

Relations between classes are defined using the following symbols :

Extension	< --	
Composition	*--	
Aggregation	o--	

It is possible to replace -- by .. to have a dotted line.

Knowing those rules, it is possible to draw the following drawings:

```
@startuml
scale 800 width
Class01 <|-- Class02
Class03 *-- Class04
Class05 o-- Class06
Class07 .. Class08
Class09 -- Class10
Class11 <|.. Class12
Class13 --> Class14
Class15 ..> Class16
Class17 ..|> Class18
Class19 <--* Class20
@enduml
```

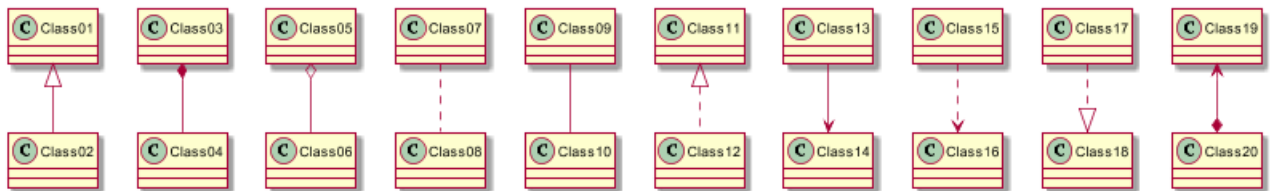

### 3.2 Label on relations

It is possible to add a label on the relation, using ":", followed by the text of the label.

For cardinality, you can use double-quotes "" on each side of the relation.

```
@startuml
Class01 "1" *-- "many" Class02 : contains
Class03 o-- Class04 : aggregation
Class05 --> "1" Class06
@enduml
```

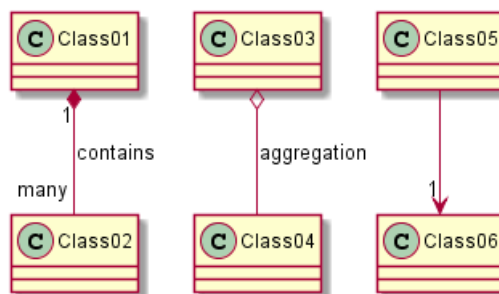

You can add an extra arrow pointing at one object showing which object acts on the other object, using < or > at the begin or at the end of the label.

```
@startuml
class Car

Driver - Car : drives >
Car *- Wheel : have 4 >
Car -- Person : < owns

@enduml
```

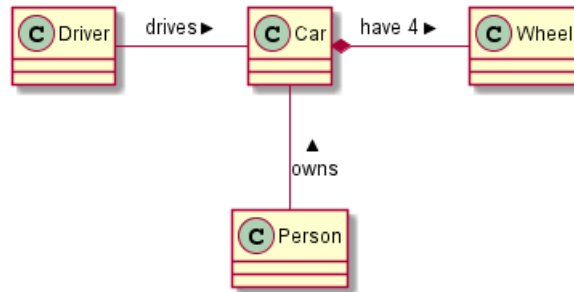

### 3.3 Adding methods

To declare fields and methods, you can use the symbol ":" followed by the field's or method's name.

The system checks for parenthesis to choose between methods and fields.

```
@startuml
Object <|-- ArrayList

Object : equals()
ArrayList : Object[] elementData
ArrayList : size()

@enduml
```

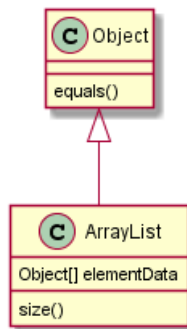

It is also possible to group between brackets { all fields and methods.

Note that the syntax is highly flexible about type/name order.

```
@startuml
class Dummy {
String data
void methods()
}

class Flight {
flightNumber : Integer
departureTime : Date
}

@enduml
```

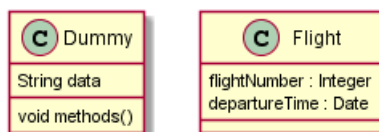



### 3.4 Defining visibility

When you define methods or fields, you can use characters to define the visibility of the corresponding item:

-	□	■	private
#	◇	◆	protected
~	△	▲	package private
+	○	●	public

```
@startuml
class Dummy {
-field1
#field2
~method1()
+method2()
}
@enduml
```

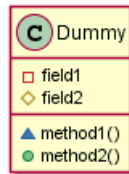

You can turn off this feature using the `skinparam classAttributeIconSize 0` command :

```
@startuml
skinparam classAttributeIconSize 0
class Dummy {
-field1
#field2
~method1()
+method2()
}
@enduml
```

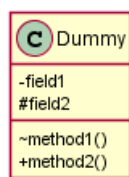

### 3.5 Abstract and Static

You can define static or abstract methods or fields using the `static` or `abstract` modifier.

These modifiers can be used at the start or at the end of the line. You can also use `classifier` instead of `static`.

```
@startuml
class Dummy {
{static} String id
{abstract} void methods()
}
@enduml
```

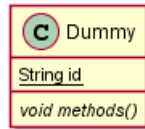

### 3.6 Advanced class body

By default, methods and fields are automatically regrouped by PlantUML. You can use separators to define your own way of ordering fields and methods. The following separators are possible : -- .. == --.

You can also use titles within the separators:

```
@startuml
class Foo1 {
You can use
several lines
..
as you want
and group
==
things together.
--
You can have as many groups
as you want
--
End of class
}

class User {
.. Simple Getter ..
+ getName()
+ getAddress()
.. Some setter ..
+ setName()
-- private data --
int age
-- encrypted --
String password
}

@enduml
```

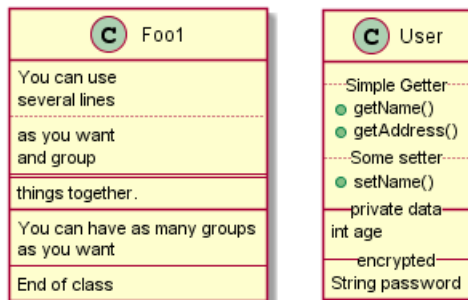

### 3.7 Notes and stereotypes

Stereotypes are defined with the `class` keyword, "`<<`" and "`>>`".

You can also define notes using `note left of`, `note right of`, `note top of`, `note bottom of` keywords.

You can also define a note on the last defined class using `note left`, `note right`, `note top`, `note bottom`.

A note can be also define alone with the `note` keywords, then linked to other objects using the `..` symbol.

```
@startuml
class Object << general >>
Object <|--- ArrayList

note top of Object : In java, every class\nnextends this one.

note "This is a floating note" as N1
note "This note is connected\nto several objects." as N2
Object .. N2
N2 .. ArrayList

class Foo
note left: On last defined class

@enduml
```

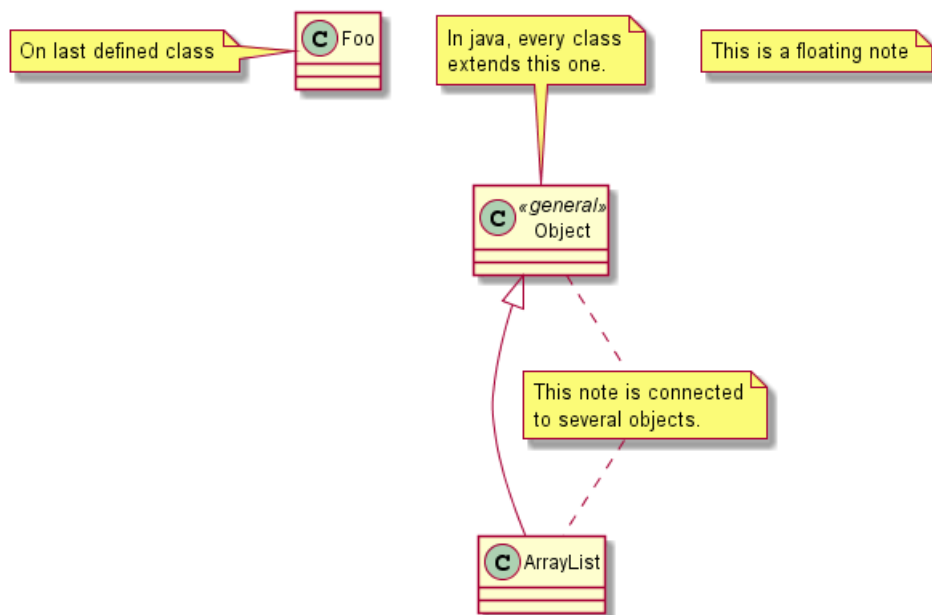

### 3.8 More on notes

It is also possible to use few html tags like :

- `<b>`
- `<u>`
- `<i>`
- `<s>`, `<del>`, `<strike>`
- `<font color="AAAAAA">` or `<font color="colorName">`
- `<color:AAAAAA>` or `<color:colorName>`
- `<size:nn>` to change font size
- `` or `<img:file>` : the file must be accessible by the filesystem

You can also have a note on several lines You can also define a note on the last defined class using note left, note right, note top, note bottom.

```
@startuml
class Foo
note left: On last defined class

note top of Object
In java, <size:18>every</size> <u>class</u>
<b>extends</b>
<i>this</i> one.
end note

note as N1
This note is <u>also</u>
<b><color:royalBlue>on several</color>
<s>words</s> lines
And this is hosted by <img:sourceforge.jpg>
end note

@enduml
```

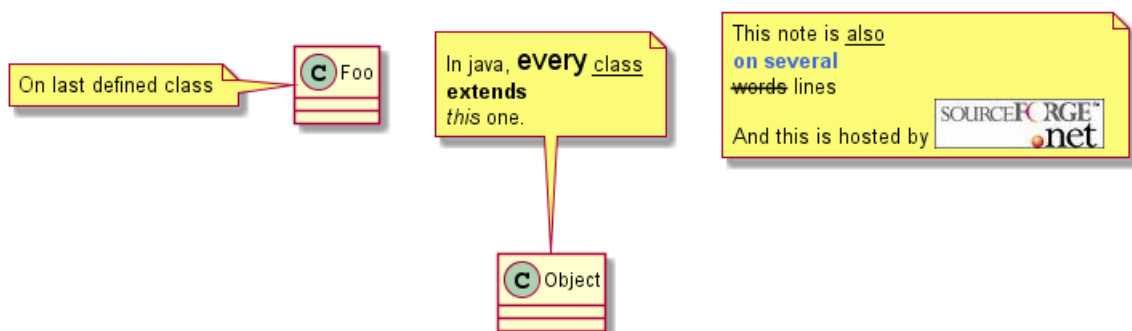

### 3.9 Note on links

It is possible to add a note on a link, just after the link definition, using `note on link`.

You can also use `note left on link`, `note right on link`, `note top on link`, `note bottom on link` if you want to change the relative position of the note with the label.

```
@startuml
class Dummy
Dummy --> Foo : A link
note on link #red: note that is red

Dummy --> Foo2 : Another link
note right on link #blue
this is my note on right link
and in blue
end note
@enduml
```

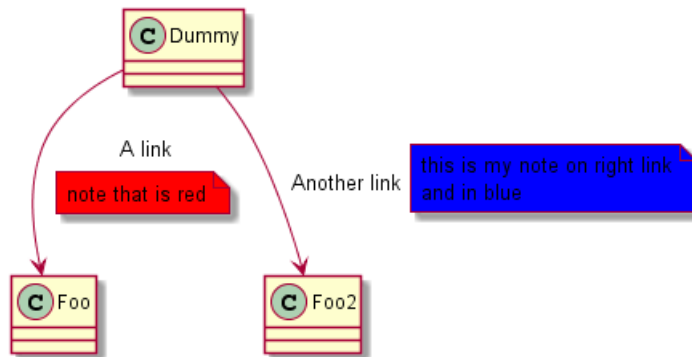

### 3.10 Abstract class and interface

You can declare a class as abstract using "abstract" or "abstract class" keywords.

The class will be printed in *italic*.

You can use the interface, annotation and enum keywords too.

```
@startuml

abstract class AbstractList
abstract AbstractCollection
interface List
interface Collection

List <|-- AbstractList
Collection <|-- AbstractCollection

Collection <|-- List
AbstractCollection <|-- AbstractList
AbstractList <|-- ArrayList

class ArrayList {
Object[] elementData
size()
}

enum TimeUnit {
DAYS
HOURS
MINUTES
}

annotation SuppressWarnings

@enduml
```

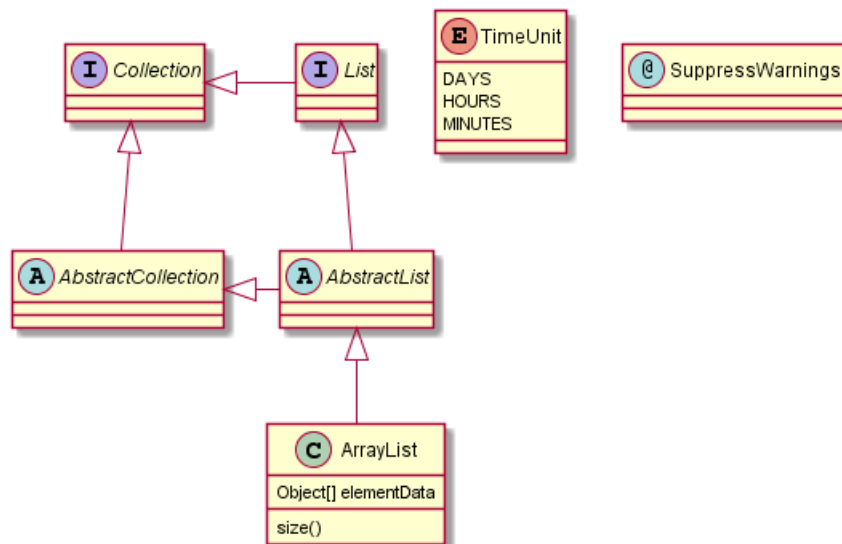

### 3.11 Using non-letters

If you want to use non-letters in the class (or enum...) display, you can either :

- Use the `as` keyword in the class definition
- Put quotes `"` around the class name

```
@startuml
class "This is my class" as class1
class class2 as "It works this way too"

class2 *-- "foo/dummy" : use
@enduml
```

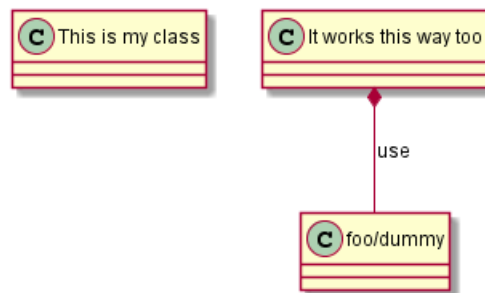



### 3.12 Hide attributes, methods...

You can parameterize the display of classes using the `hide/show` command.

The basic command is: `hide empty members`. This command will hide attributes or methods if they are empty.

Instead of `empty members`, you can use:

- `empty fields` or `empty attributes` for empty fields,
- `empty methods` for empty methods,
- `fields` or `attributes` which will hide fields, even if they are described,
- `methods` which will hide methods, even if they are described,
- `members` which will hide fields and methods, even if they are described,
- `circle` for the circled character in front of class name,
- `stereotype` for the stereotype.

You can also provide, just after the `hide` or `show` keyword:

- `class` for all classes,
- `interface` for all interfaces,
- `enum` for all enums,
- `<<foo1>>` for classes which are stereotyped with `foo1`,
- an existing class name.

You can use several `show/hide` commands to define rules and exceptions.

```
@startuml
class Dummy1 {
+myMethods()
}

class Dummy2 {
+hiddenMethod()
}

class Dummy3 <<Serializable>> {
String name
}

hide members
hide <<Serializable>> circle
show Dummy1 methods
show <<Serializable>> fields

@enduml
```

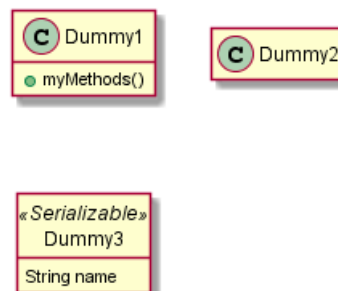

### 3.13 Hide classes

You can also use the `show/hide` commands to hide classes.

This may be useful if you define a large included file, and if you want to hide some classes after file inclusion.

```
@startuml
class Foo1
class Foo2

Foo2 *-- Foo1

hide Foo2

@enduml
```



### 3.14 Use generics

You can also use bracket `<` and `>` to define generics usage in a class.

```
@startuml
class Foo<? extends Element> {
int size()
}
Foo *- Element

@enduml
```

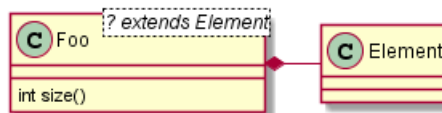

### 3.15 Specific Spot

Usually, a spotted character (C, I, E or A) is used for classes, interface, enum and abstract classes.

But you can define your own spot for a class when you define the stereotype, adding a single character and a color, like in this example:

```
@startuml
class System << (S,#FF7700) Singleton >>
class Date << (D,orchid) >>

@enduml
```

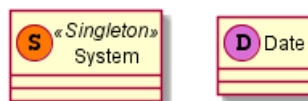

### 3.16 Packages

You can define a package using the `package` keyword, and optionally declare a background color for your package (Using a html color code or name).

Note that package definitions can be nested.

```
@startuml
package "Classic Collections" #DDDDDD {
Object <|-- ArrayList
}

package net.sourceforge.plantuml {
Object <|-- Demo1
Demo1 *- Demo2
}

@enduml
```

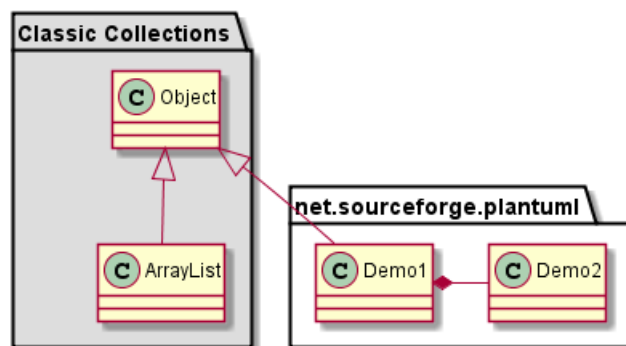

### 3.17 Packages style

There are different styles available for packages.

You can specify them either by setting a default style with the command `: skinparam packageStyle`, or by using a stereotype on the package:

```
@startuml
package foo1 <<Node>> {
class Class1
}

package foo2 <<Rect>> {
class Class2
}

package foo3 <<Folder>> {
class Class3
}

package foo4 <<Frame>> {
class Class4
}

package foo5 <<Cloud>> {
class Class5
}

package foo6 <<Database>> {
class Class6
}

@enduml
```

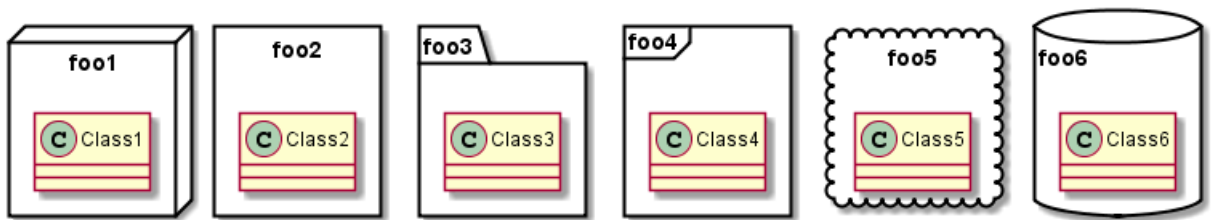

You can also define links between packages, like in the following example:

```
@startuml
skinparam packageStyle rect

package foo1.foo2 {
}

package foo1.foo2.foo3 {
class Object
}

foo1.foo2 +-- foo1.foo2.foo3

@enduml
```

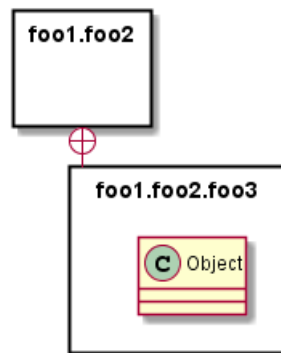

### 3.18 Namespaces

In packages, the name of a class is the unique identifier of this class. It means that you cannot have two classes with the very same name in different packages.

In that case, you should use namespaces instead of packages.

You can refer to classes from other namespaces by fully qualify them. Classes from the default namespace are qualified with a starting dot.

Note that you don't have to explicitly create namespace : a fully qualified class is automatically put in the right namespace.

```
@startuml
class BaseClass

namespace net.dummy #DDDDDD {
.BaseClass <|-- Person
Meeting o-- Person

.BaseClass <|-- Meeting
}

namespace net.foo {
net.dummy.Person <|-- Person
}
```

```

.BaseClass <|-- Person
net.dummy.Meeting o-- Person
}

.BaseClass <|-- net.unused.Person

@enduml

```

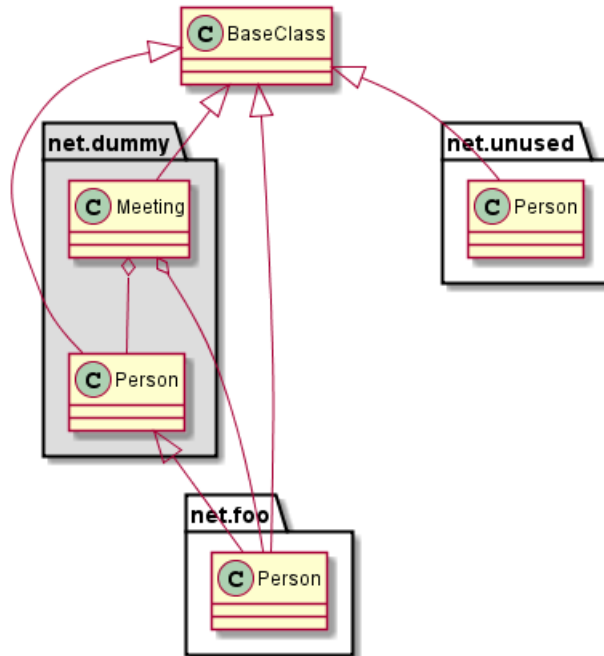

### 3.19 Automatic namespace creation

You can define another separator (other than the dot) using the command: `set namespaceSeparator ???`.

```

@startuml

set namespaceSeparator ::
class X1::X2::foo {
some info
}

@enduml

```

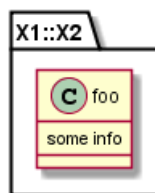

You can disable automatic package creation using the command `set namespaceSeparator none`.

```

@startuml

set namespaceSeparator none
class X1.X2.foo {
some info
}

@enduml

```

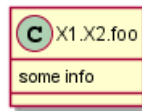

### 3.20 Lollipop interface

You can also define lollipops interface on classes, using the following syntax:

- `bar ()- foo`
- `bar ()-- foo`
- `foo -() bar`

```
@startuml
class foo
bar ()- foo
@enduml
```

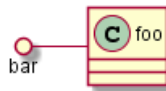

### 3.21 Changing arrows direction

By default, links between classes have two dashes -- and are vertically oriented. It is possible to use horizontal link by putting a single dash (or dot) like this:

```
@startuml
Room o- Student
Room *-- Chair
@enduml
```

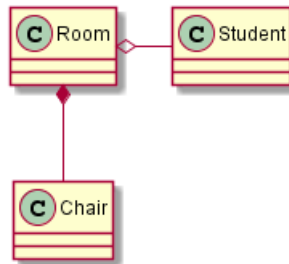

You can also change directions by reversing the link:

```
@startuml
Student -o Room
Chair --* Room
@enduml
```

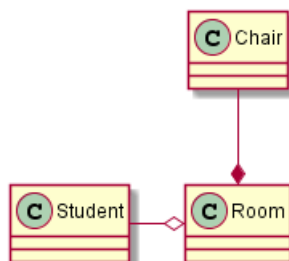

It is also possible to change arrow direction by adding `left`, `right`, `up` or `down` keywords inside the arrow:

```
@startuml
foo -left-> dummyLeft
foo -right-> dummyRight
foo -up-> dummyUp
foo -down-> dummyDown
@enduml
```

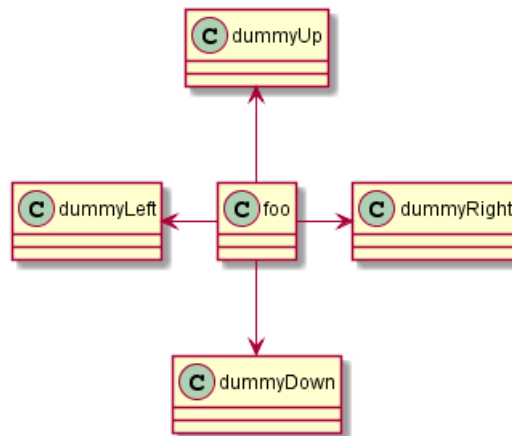

You can shorten the arrow by using only the first character of the direction (for example, `-d-` instead of `-down-`) or the two first characters (`-do-`).

Please note that you should not abuse this functionality : *Graphviz* gives usually good results without tweaking.

### 3.22 Title the diagram

The `title` keyword is used to put a title.

You can use `title` and `end title` keywords for a longer title, as in sequence diagrams.

```
@startuml
title Simple <b>example</b>\nof title
Object <|-- ArrayList
@enduml
```

#### Simple example of title

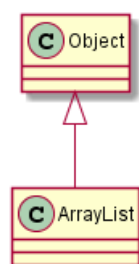

### 3.23 Legend the diagram

The `legend` and `end legend` keywords is used to put a legend.

You can optionally specify to have `left`, `right` or `center` alignment for the legend.

```

@startuml
Object <|-- ArrayList
legend right
<b>Object</b> and <b>ArrayList</b>
are simple class
endlegend
@enduml

```

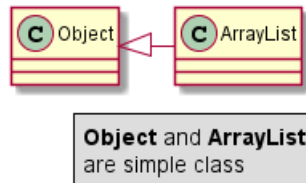

### 3.24 Association classes

You can define *association class* after that a relation has been defined between two classes, like in this example:

```

@startuml
class Student {
Name
}
Student "0..*" - "1..*" Course
(Student, Course) .. Enrollment

class Enrollment {
drop()
cancel()
}
@enduml

```

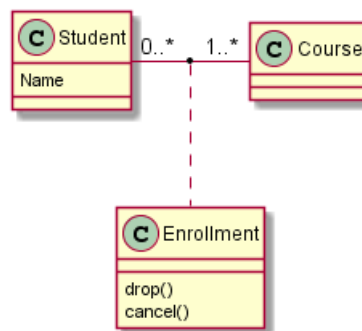

You can define it in another direction:

```

@startuml
class Student {
Name
}
Student "0..*" -- "1..*" Course
(Student, Course) . Enrollment

class Enrollment {
drop()
cancel()
}
@enduml

```



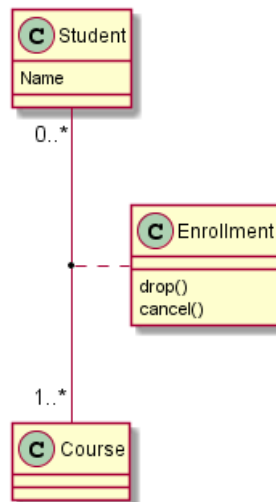

### 3.25 Skinparam

You can use the `skinparam` command to change colors and fonts for the drawing.

You can use this command :

- In the diagram definition, like any other commands,
- In an included file,
- In a configuration file, provided in the command line or the ANT task.

```

@startuml
skinparam class {
  BackgroundColor PaleGreen
  ArrowColor SeaGreen
  BorderColor SpringGreen
}
skinparam stereotypeCBackgroundColor YellowGreen

Class01 "1" *-- "many" Class02 : contains
Class03 o-- Class04 : aggregation

@enduml
  
```

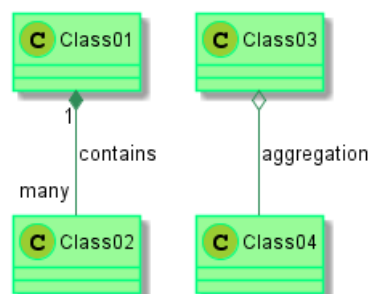

### 3.26 Skinned Stereotypes

You can define specific color and fonts for stereotyped classes.

```

@startuml
skinparam class {
  BackgroundColor PaleGreen
  
```

```

ArrowColor SeaGreen
BorderColor SpringGreen
BackgroundColor<<Foo>> Wheat
BorderColor<<Foo>> Tomato
}
skinparam stereotypeCBackgroundColor YellowGreen
skinparam stereotypeCBackgroundColor<< Foo >> DimGray

Class01 << Foo >>
Class01 "1" *-- "many" Class02 : contains

Class03<<Foo>> o-- Class04 : aggregation

@enduml

```

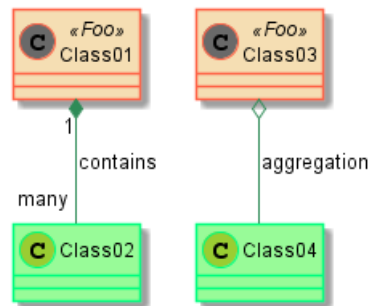

### 3.27 Color gradient

It's possible to declare individual color for classes or note using the notation.

You can use either standard color name or RGB code.

You can also use color gradient in background, with the following syntax: two colors names separated either by:

- |,
- /,
- \,
- or -

depending the direction of the gradient.

For example, you could have:

```

@startuml

skinparam backgroundcolor AntiqueWhite/Gold
skinparam classBackgroundColor Wheat|CornflowerBlue

class Foo #red-green
note left of Foo #blue\9932CC {
this is my
note on this class
}

package example #GreenYellow/LightGoldenRodYellow {
class Dummy
}

@enduml

```

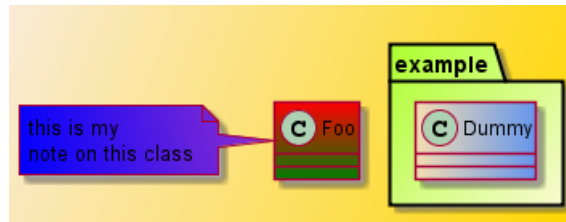

### 3.28 Splitting large files

Sometimes, you will get some very large image files.

You can use the "page (hpages)x(vpages)" command to split the generated image into several files :

**hpages** is a number that indicated the number of horizontal pages, and **vpages** is a number that indicated the number of vertical pages.

```
@startuml
' Split into 4 pages
page 2x2

class BaseClass

namespace net.dummy #DDDDDD {
.BaseClass <|-- Person
Meeting o-- Person

.BaseClass <|-- Meeting
}

namespace net.foo {
net.dummy.Person <|-- Person
.BaseClass <|-- Person

net.dummy.Meeting o-- Person
}

BaseClass <|-- net.unused.Person
@enduml
```

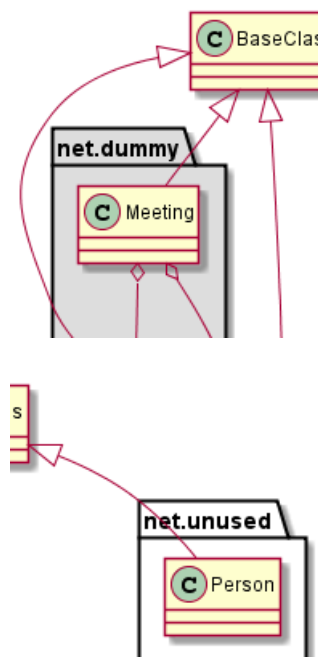

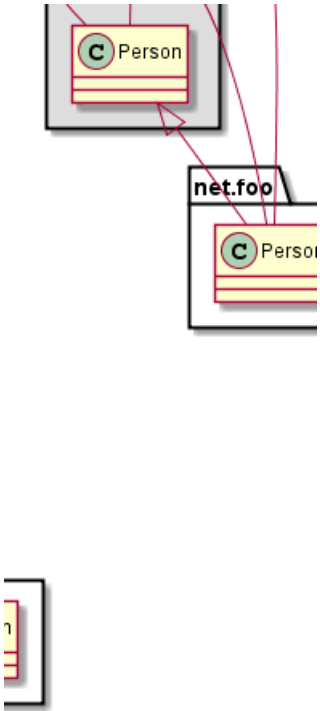

## 4 Activity Diagram

### 4.1 Simple Activity

You can use (\*) for the starting point and ending point of the activity diagram.

In some occasion, you may want to use (\*top) to force the starting point to be at the top of the diagram.

Use --> for arrows.

```
@startuml
```

```
(*) --> "First Activity"
"First Activity" --> (*)
```

```
@enduml
```



### 4.2 Label on arrows

By default, an arrow starts at the last used activity.

You can put a label on an arrow using brackets [ and ] just after the arrow definition.

```
@startuml
```

```
(*) --> "First Activity"
-->[You can put also labels] "Second Activity"
--> (*)
```

```
@enduml
```

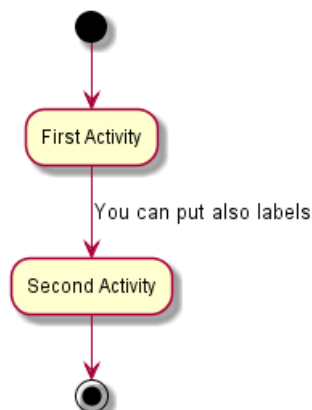

### 4.3 Changing arrow direction

You can use -> for horizontal arrows. It is possible to force arrow's direction using the following syntax:

- -down-> (default arrow)
- -right-> or ->
- -left->
- -up->

```
@startuml
(*) -up-> "First Activity"
-right-> "Second Activity"
--> "Third Activity"
-left-> (*)
@enduml
```

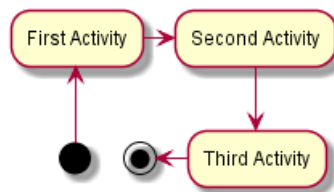

#### 4.4 Branches

You can use `if/then/else` keywords to define branches.

```
@startuml
(*) --> "Initialization"

if "Some Test" then
-->[true] "Some Activity"
--> "Another activity"
-right-> (*)
else
->[false] "Something else"
-->[Ending process] (*)
endif
@enduml
```

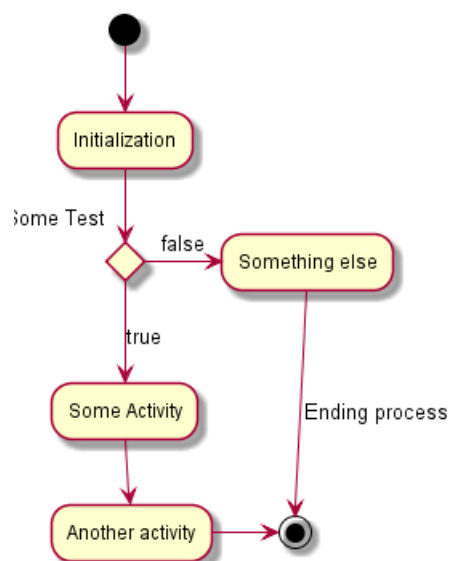

Unfortunately, you will have to sometimes repeat the same activity in the diagram text:

```

@startuml
(*) --> "check input"
If "input is verbose" then
--> [Yes] "turn on verbosity"
--> "run command"
else
--> "run command"
Endif
-->(*)
@enduml

```

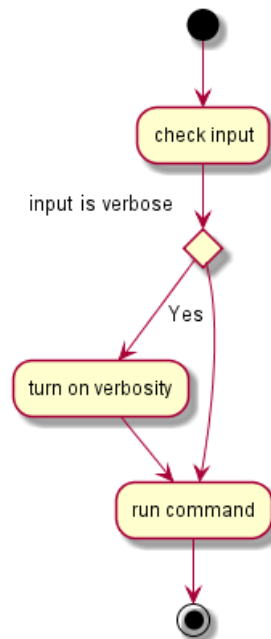

## 4.5 More on Branches

By default, a branch is connected to the last defined activity, but it is possible to override this and to define a link with the `if` keywords.

It is also possible to nest branches.

```

@startuml
(*) --> if "Some Test" then
-->[true] "activity 1"

if "" then
-> "activity 3" as a3
else
if "Other test" then
-left-> "activity 5"
else
--> "activity 6"
endif
endif

else
->[false] "activity 2"

endif

a3 --> if "last test" then
--> "activity 7"
else
-> "activity 8"
endif

```

```
endif
@enduml
```

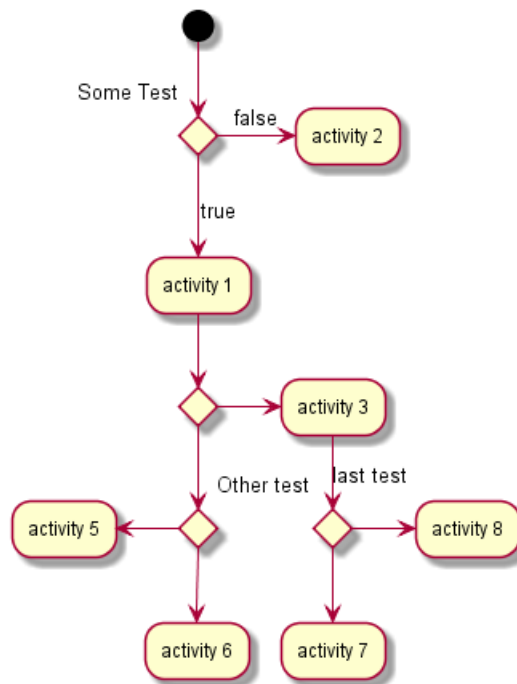

## 4.6 Synchronization

You can use `=== code ===` to display synchronization bars.

```
@startuml
(*) --> ===B1===
--> "Parallel Activity 1"
--> ===B2===

===B1=== --> "Parallel Activity 2"
--> ===B2===

--> (*)
@enduml
```

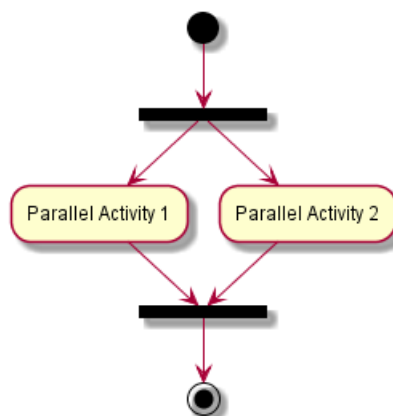



## 4.7 Long activity description

When you declare activities, you can span on several lines the description text. You can also add `\n` in the description.

You can also give a short code to the activity with the `as` keyword. This code can be used latter in the diagram description.

```
@startuml
(*) -left-> "this <size:20>activity</size>
is <b>very</b> <color:red>long2</color>
and defined on several lines
that contains many <i>text</i>" as A1

-up-> "Another activity\n on several lines"

A1 --> "Short activity <img:sourceforge.jpg>"
@enduml
```

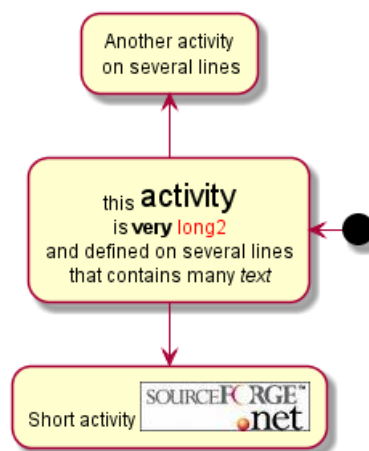

## 4.8 Notes

You can add notes on a activity using the commands `note left`, `note right`, `note top` or `note bottom`, just after the description of the activity you want to note.

If you want to put a note on the starting point, define the note at the very beginning of the diagram description.

You can also have a note on several lines, using the `endnote` keywords.

```
@startuml
(*) --> "Some Activity"
note right: This activity has to be defined
"Some Activity" --> (*)
note left
This note is on
several lines
end note
@enduml
```

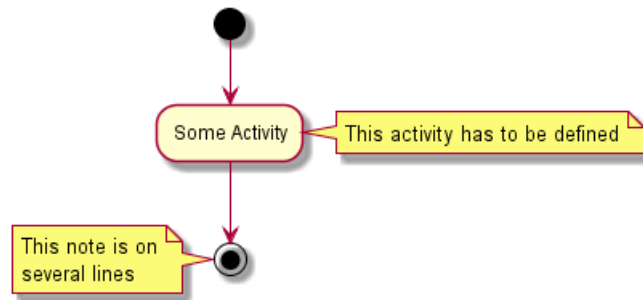

## 4.9 Partition

You can define a partition using the `partition` keyword, and optionally declare a background color for your partition (Using a html color code or name)

When you declare activities, they are automatically put in the last used partition.

You can close the partition definition using a closing bracket `}`.

```

@startuml

partition Conductor {
(*) --> "Climbs on Platform"
--> === S1 ===
--> Bows
}

partition Audience LightSkyBlue {
=== S1 === --> Applauds
}

partition Conductor {
Bows --> === S2 ===
--> WavesArmes
Applauds --> === S2 ===
}

partition Orchestra #CCCCEE {
WavesArmes --> Introduction
--> "Play music"
}

@enduml
  
```

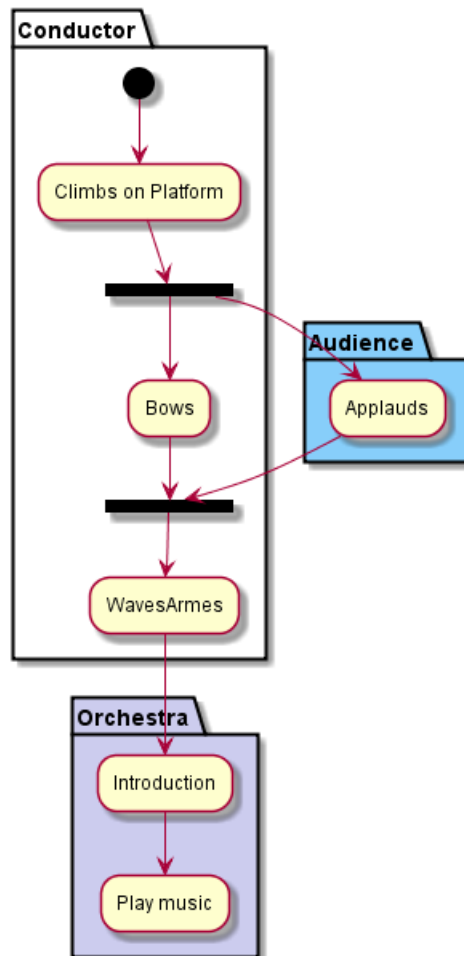

#### 4.10 Title the diagram

The `title` keywords is used to put a title.

You can use `title` and `end title` keywords for a longer title, as in sequence diagrams.

```
@startuml
title Simple example\nof title
```

```
(*) --> "First activity"
```

```
--> (*)
```

```
@enduml
```

Simple example  
of title



## 4.11 Skinparam

You can use the `skinparam` command to change colors and fonts for the drawing.

You can use this command :

- In the diagram definition, like any other commands,
- In an included file,
- In a configuration file, provided in the command line or the ANT task.

You can define specific color and fonts for stereotyped activities.

```
@startuml
skinparam backgroundColor #AFFFFFF
skinparam activity {
StartColor red
BarColor SaddleBrown
EndColor Silver
BackgroundColor Peru
BackgroundColor<< Begin >> Olive
BorderColor Peru
FontName Impact
}

(*) --> "Climbs on Platform" << Begin >>
--> === S1 ===
--> Bows
--> === S2 ===
--> WavesArmes
--> (*)

@enduml
```

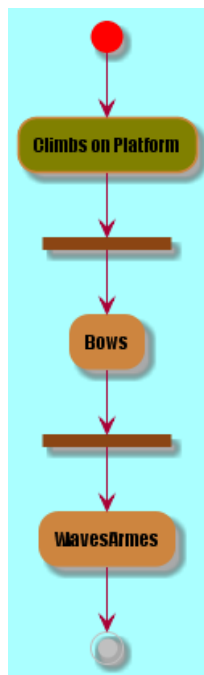

## 4.12 Octagon

You can change the shape of activities to octagon using the `skinparam activityShape octagon` command.

```
@startuml
'Default is skinparam activityShape roundBox
skinparam activityShape octagon
```

```
(*) --> "First Activity"
"First Activity" --> (*)

@enduml
```



### 4.13 Complete example

```
@startuml
title Servlet Container

(*) --> "ClickServlet.handleRequest()"
--> "new Page"

if "Page.onSecurityCheck" then
->[true] "Page.onInit()"

if "isForward?" then
->[no] "Process controls"

if "continue processing?" then
-->[yes] ===RENDERING===
else
-->[no] ===REDIRECT_CHECK===
endif

else
-->[yes] ===RENDERING===
endif

if "is Post?" then
-->[yes] "Page.onPost()"
--> "Page.onRender()" as render
--> ===REDIRECT_CHECK===
else
-->[no] "Page.onGet()"
--> render
endif

else
-->[false] ===REDIRECT_CHECK===
endif

if "Do redirect?" then
->[yes] "redirect request"
--> ==BEFORE_DESTROY===
else
if "Do Forward?" then
-left->[yes] "Forward request"
--> ==BEFORE_DESTROY===
else
-right->[no] "Render page template"
--> ==BEFORE_DESTROY===
endif
endif

--> "Page.onDestroy()"
-->(*)
```

```
@enduml
```

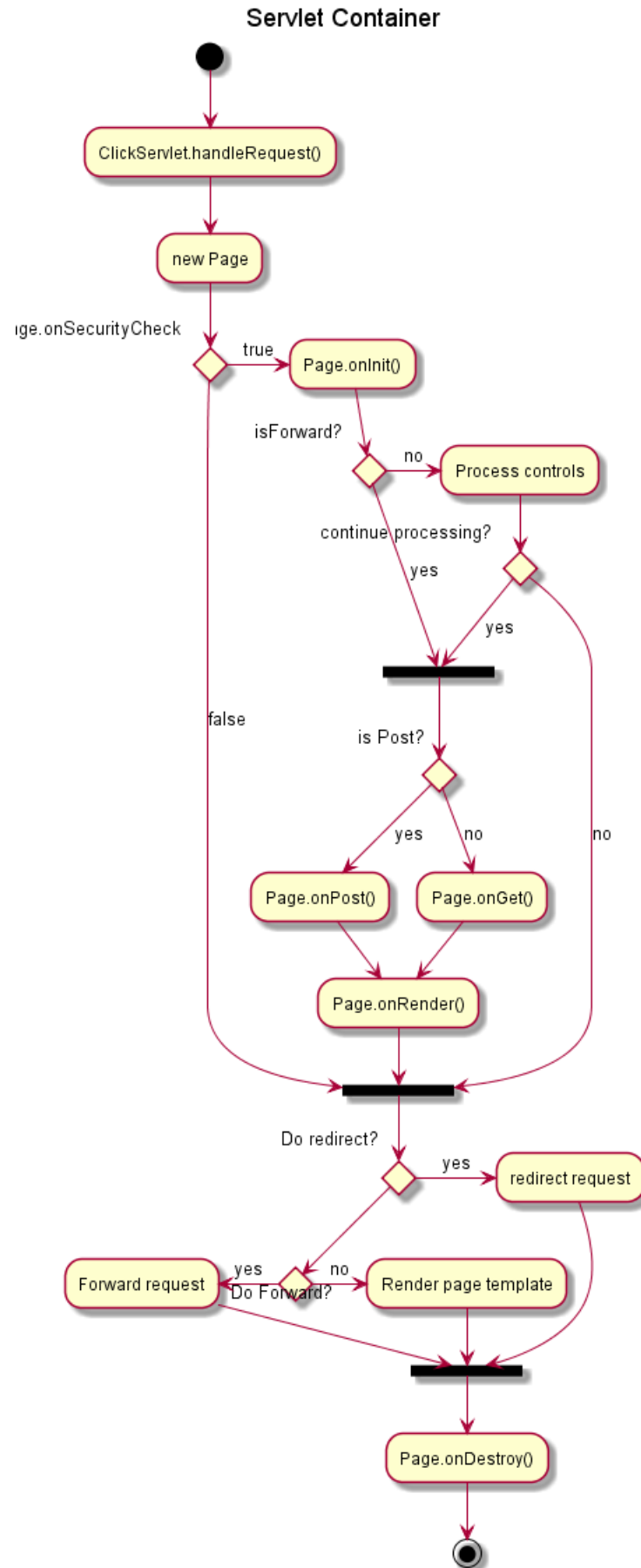

## 5 Activity Diagram (beta)

Current syntax for activity diagram has several limitations and drawbacks (for example, it's difficult to maintain).

So a completely new syntax and implementation is proposed as **beta version** to users (starting with V7947), so that we could define a better format and syntax.

Another advantage of this new implementation is that it's done without the need of having Graphviz installed (as for sequence diagrams).

The new syntax will replace the old one. However, for compatibility reason, the old syntax will still be recognized, to ensure *ascending compatibility*.

Users are simply encouraged to migrate to the new syntax.

### 5.1 Simple Activity

Activities label starts with `:` and ends with `;`.

Text formatting can be done using creole wiki syntax.

They are implicitly linked in their definition order.

```
@startuml
:Hello world;
:This is on defined on
several lines;
@enduml
```

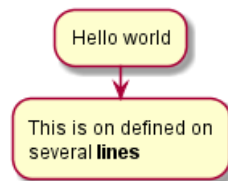

### 5.2 Start/Stop

You can use `start` and `stop` keywords to denote the beginning and the end of a diagram.

```
@startuml
start
:Hello world;
:This is on defined on
several lines;
stop
@enduml
```

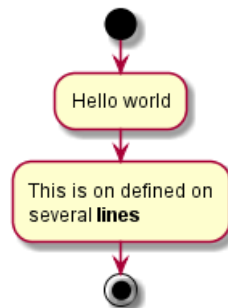



### 5.3 Conditional

You can use `if`, `then` and `else` keywords to put tests in your diagram. Labels can be provided using parentheses.

```
@startuml
start
if (Graphviz installed?) then (yes)
:process all\ndiagrams;
else (no)
:process only
__sequence__ and __activity__ diagrams;
endif
stop
@enduml
```

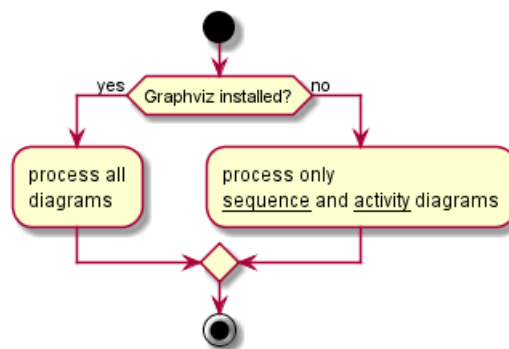

You can use the `elseif` keyword to have several tests :

```
@startuml
start
if (condition A) then (yes)
:Text 1;
elseif (condition B) then (yes)
:Text 2;
stop
elseif (condition C) then (yes)
:Text 3;
elseif (condition D) then (yes)
:Text 4;
else (nothing)
:Text else;
endif
stop
@enduml
```

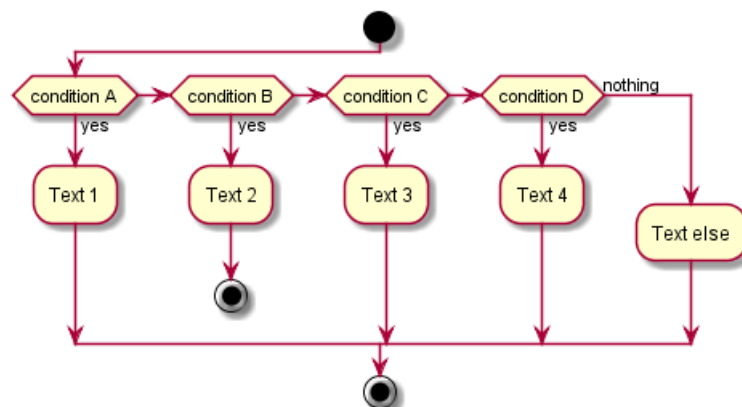

## 5.4 Repeat loop

You can use `repeat` and `repeatwhile` keywords to have repeat loops.

```
@startuml
start
repeat
:read data;
:generate diagrams;
repeat while (more data?)
stop
@enduml
```

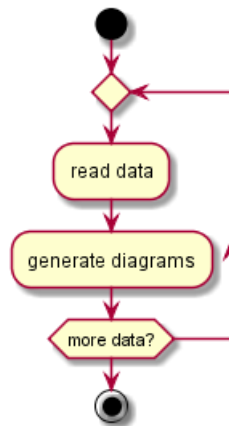

## 5.5 While loop

You can use `while` and `end while` keywords to have repeat loops.

```
@startuml
start
while (data available?)
:read data;
:generate diagrams;
endwhile
stop
@enduml
```

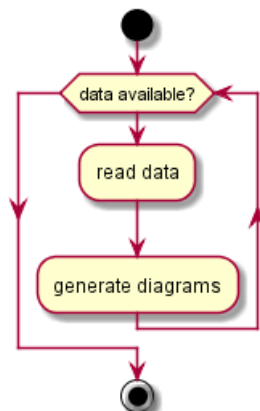

It is possible to provide a label after the `endwhile` keyword, or using the `is` keyword.

```
@startuml
while (check filesize ?) is (not empty)
:read file;
endwhile (empty)
:close file;
@enduml
```

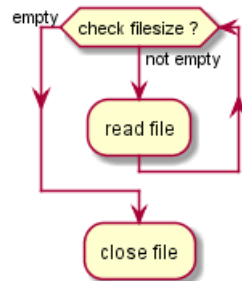

## 5.6 Parallel processing

You can use `fork`, `fork again` and `end fork` keywords to denote parallel processing.

```
@startuml
start

if (multiprocessor?) then (yes)
fork
:Treatment 1;
fork again
:Treatment 2;
end fork
else (monoproc)
:Treatment 1;
:Treatment 2;
endif

@enduml
```

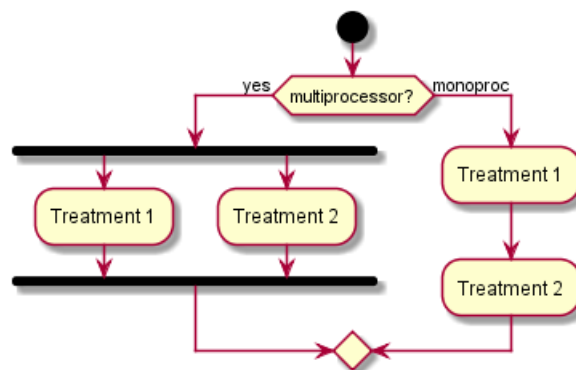

## 5.7 Notes

Text formatting can be done using creole wiki syntax.

```
@startuml
start
:foo1;
```

```

note left: This is a note
:foo2;
note right
This note is on several
//lines// and can
contain <b>HTML</b>
====
* Calling the method "foo()" is prohibited
end note
stop

@enduml

```

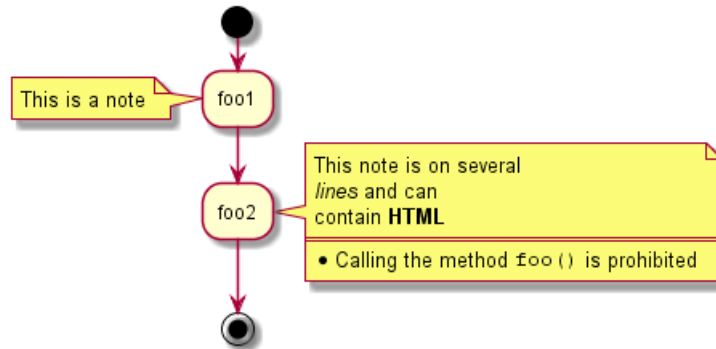

## 5.8 Title Legend

You can add title, header, footer, legend to a diagram:

```

@startuml
title this is my title
if (condition?) then (yes)
:yes;
else (no)
:no;
note right
this is a note
end note
endif
stop

legend
this is the legend
endlegend

footer dummy footer
header
this is
a long __dummy__ header
end header

@enduml

```

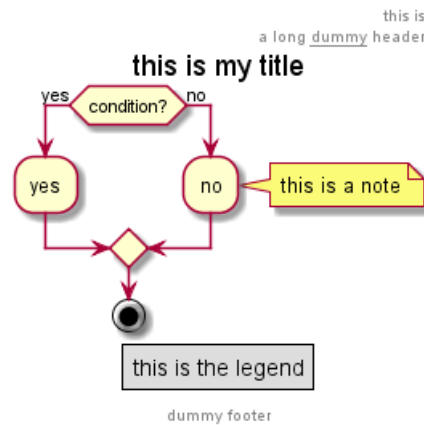

## 5.9 Colors

You can use specify a color for some activities.

```
@startuml
```

```
start
:starting progress;
#HotPink:reading configuration files
These files should edited at this point!;
#AAAAAA:ending of the process;
```

```
@enduml
```

## 5.10 Arrows

Using the -> notation, you can add texts to arrow, and change their color.

```
@startuml
:foo1;
-> You can put text on arrows;
if (test) then
-[#blue]->
:foo2;
-[#green]-> The text can
also be on several lines
and very long...;
:foo3;
else
-[#black]->
:foo4;
endif
-[#gray]->
:foo5;
@enduml
```

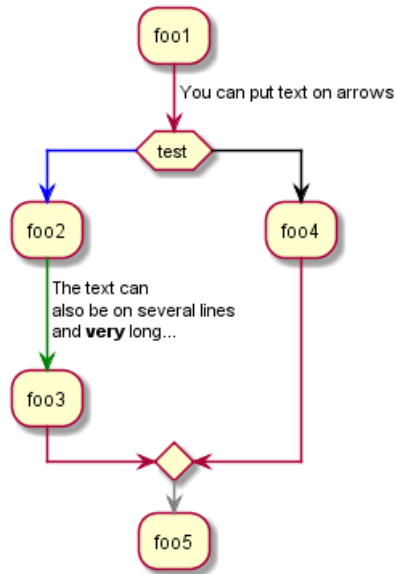

## 5.11 Grouping

You can group activity together by defining partition:

```

@startuml
start
partition Initialization {
:read config file;
:init internal variable;
}
partition Running {
:wait for user interaction;
:print information;
}
stop
@enduml
  
```

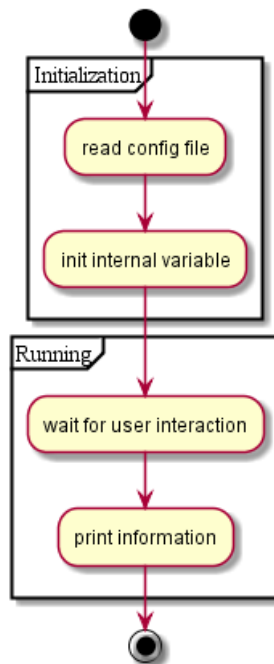

## 5.12 Swimlanes

Using pipe |, you can define swimlanes.

It's also possible to change swimlanes color.

```
@startuml
|Swimlane1|
start
:foo1;
|#AntiqueWhite|Swimlane2|
:foo2;
:foo3;
|Swimlane1|
:foo4;
|Swimlane2|
:foo5;
stop
@enduml
```

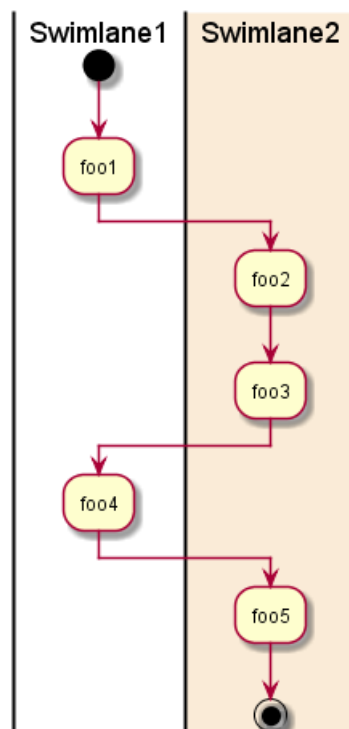

## 5.13 Detach

It's possible to remove an arrow using the detach keyword.

```
@startuml
:start;
fork
:foo1;
:foo2;
fork again
:foo3;
detach
endfork
if (foo4) then
:foo5;
detach
endif
:foo6;
detach
:foo7;
```

```
stop
@enduml
```

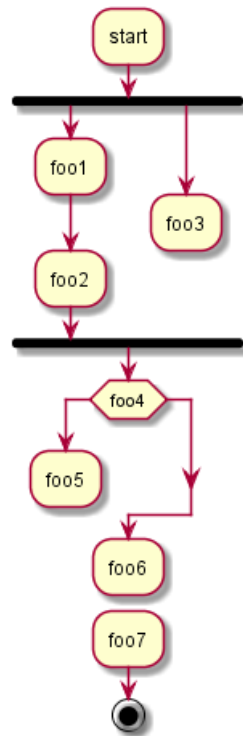

## 5.14 SDL

By changing the final ; separator, you can set different rendering for the activity:

- |
- <
- >
- /
- ]
- }

```

@startuml
:Ready;
:next(o)|
:Receiving;
split
:nak(i)<
:ack(o)>
split again
:ack(i)<
:next(o)
on several line|
:i := i + 1]
:ack(o)>
split again
:err(i)<
:nak(o)>
split again
:foo/
split again
:i > 5}
stop
end split
:finish;
@enduml
```



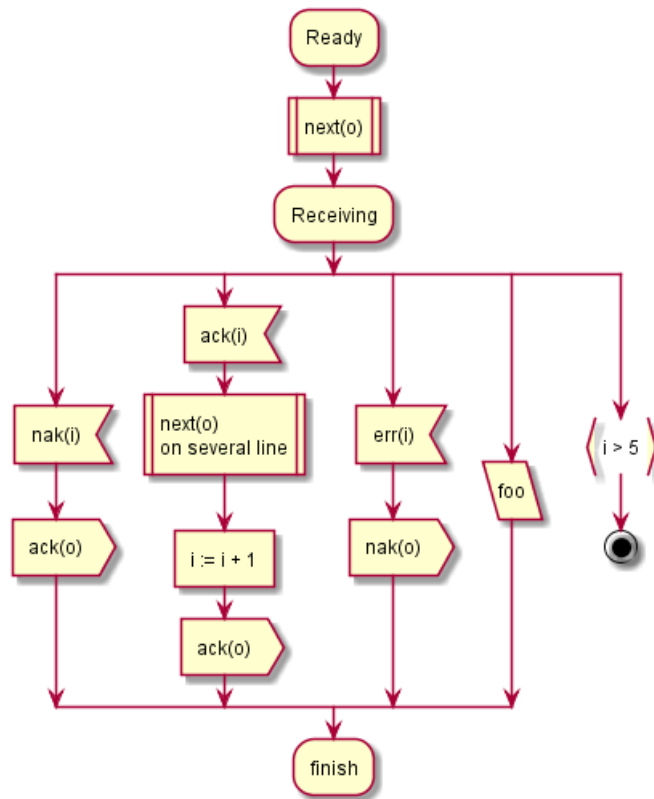

## 5.15 Complete example

```

@startuml

start
:ClickServlet.handleRequest();
:new page;
if (Page.onSecurityCheck) then (true)
:Page.onInit();
if (isForward?) then (no)
:Process controls;
if (continue processing?) then (no)
stop
endif
endif

if (isPost?) then (yes)
:Page.onPost();
else (no)
:Page.onGet();
endif
:Page.onRender();
endif
else (false)
endif

if (do redirect?) then (yes)
:redirect process;
else
if (do forward?) then (yes)
:Forward request;
else (no)
:Render page template;
endif
endif

stop

@enduml

```

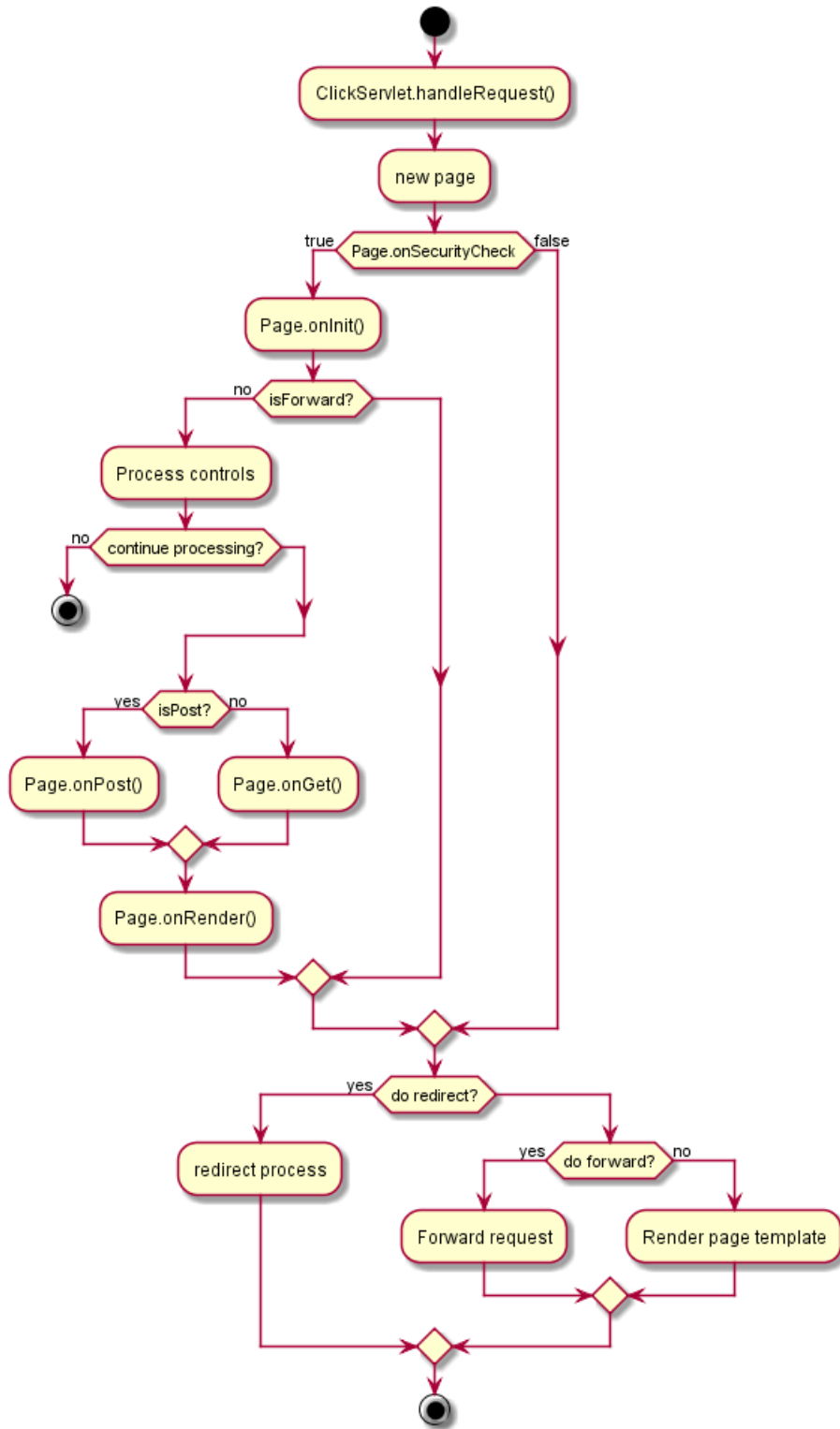

## 6 Component Diagram

### 6.1 Components

Components must be bracketed.

You can also use the `component` keyword to defines a component. And you can define an alias, using the `as` keyword. This alias will be used latter, when defining relations.

```
@startuml
[First component]
[Another component] as Comp2
component Comp3
component [Last\ncomponent] as Comp4
@enduml
```

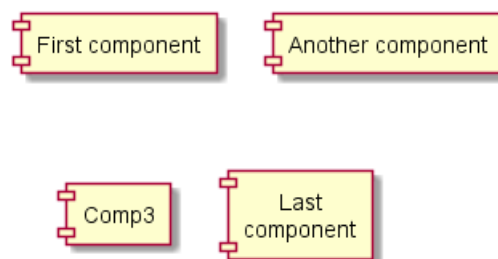

### 6.2 Interfaces

Interface can be defined using the `()` symbol (because this looks like a circle).

You can also use the `interface` keyword to defines an interface. And you can define an alias, using the `as` keyword. This alias will be used latter, when defining relations.

We will see latter that interface definition is optional.

```
@startuml
() "First Interface"
() "Another interface" as Interf2
interface Interf3
interface "Last\ninterface" as Interf4
@enduml
```

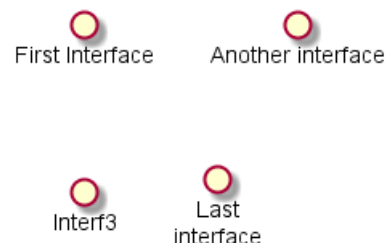

### 6.3 Basic example

Links between elements are made using combinations of dotted line (`..`), straight line (`--`), and arrows (`-->`) symbols.

```

@startuml
DataAccess - [First Component]
[First Component] ..> HTTP : use
@enduml

```

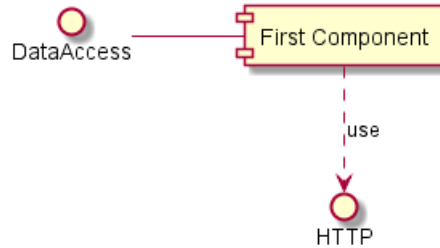

## 6.4 Using notes

You can use the `note left of`, `note right of`, `note top of`, `note bottom of` keywords to define notes related to a single object.

A note can also be defined alone with the `note` keywords, then linked to other objects using the `..` symbol.

```

@startuml
interface "Data Access" as DA
DA - [First Component]
[First Component] ..> HTTP : use

note left of HTTP : Web Service only

note right of [First Component]
A note can also
be on several lines
end note
@enduml

```

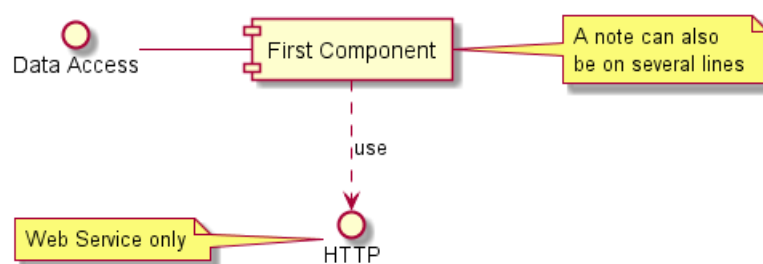

## 6.5 Grouping Components

You can use several keywords to group components and interfaces together:

- package
- node
- folder
- frame
- cloud
- database

```

@startuml

package "Some Group" {
  HTTP - [First Component]
  [Another Component]
}

node "Other Groups" {
  FTP - [Second Component]
  [First Component] --> FTP
}

cloud {
  [Example 1]
}

database "MySQL" {
  folder "This is my folder" {
    [Folder 3]
  }
  frame "Foo" {
    [Frame 4]
  }
}

[Another Component] --> [Example 1]
[Example 1] --> [Folder 3]
[Folder 3] --> [Frame 4]

@enduml

```

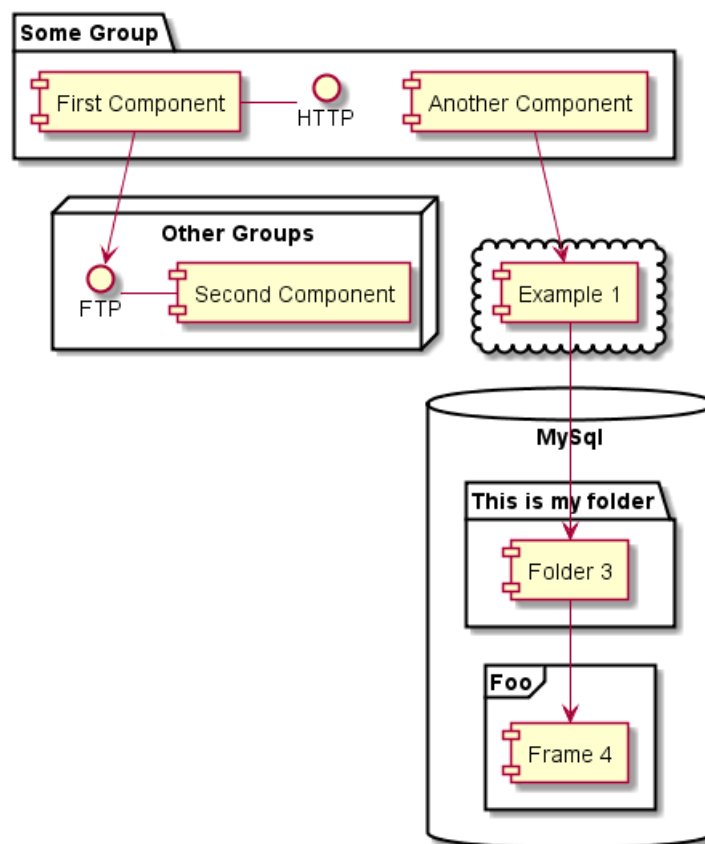

## 6.6 Changing arrows direction

By default, links between classes have two dashes -- and are vertically oriented. It is possible to use horizontal link by putting a single dash (or dot) like this:

```
@startuml
[Component] --> Interface1
[Component] -> Interface2
@enduml
```

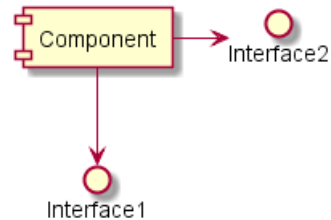

You can also change directions by reversing the link:

```
@startuml
Interface1 <-- [Component]
Interface2 <- [Component]
@enduml
```

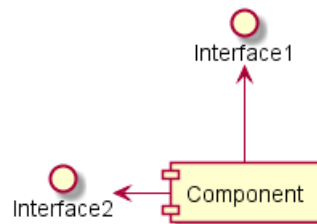

It is also possible to change arrow direction by adding `left`, `right`, `up` or `down` keywords inside the arrow:

```
@startuml
[Component] -left-> left
[Component] -right-> right
[Component] -up-> up
[Component] -down-> down
@enduml
```

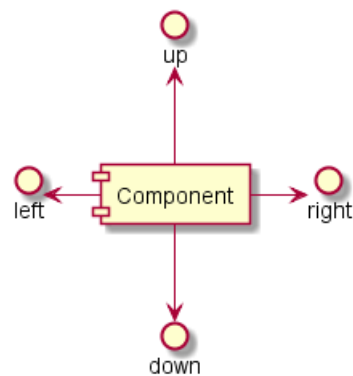

You can shorten the arrow by using only the first character of the direction (for example, `-d-` instead of `-down-`) or the two first characters (`-do-`).

Please note that you should not abuse this functionality : *Graphviz* gives usually good results without tweaking.

## 6.7 Title the diagram

The `title` keywords is used to put a title.

You can use `title` and `end title` keywords for a longer title, as in sequence diagrams.

```
@startuml
title Very simple component\ndiagram

interface "Data Access" as DA

DA - [First Component]
[First Component] ..> HTTP : use

@enduml
```

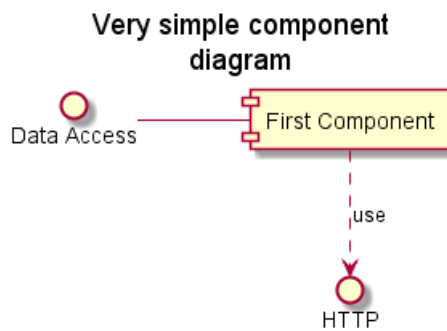

## 6.8 Use UML2 notation

The `skinparam componentStyle uml2` command is used to switch to UML2 notation.

```
@startuml
skinparam componentStyle uml2

interface "Data Access" as DA

DA - [First Component]
[First Component] ..> HTTP : use

@enduml
```

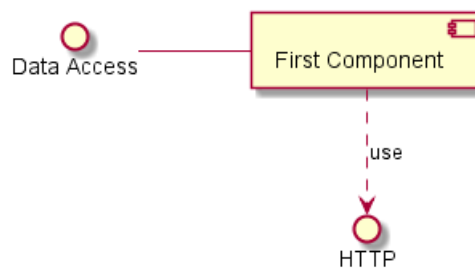

## 6.9 Individual colors

You can specify a color after component definition.

```
@startuml
component [Web Server] #Yellow
@enduml
```



## 6.10 Skinparam

You can use the `skinparam` command to change colors and fonts for the drawing.

You can use this command :

- In the diagram definition, like any other commands,
- In an included file,
- In a configuration file, provided in the command line or the ANT task.

You can define specific color and fonts for stereotyped components and interfaces.

```
@startuml
skinparam component {
FontSize 13
InterfaceBackgroundColor RosyBrown
InterfaceBorderColor orange
BackgroundColor<<Apache>> Red
BorderColor<<Apache>> #FF6655
FontName Courier
BorderColor black
BackgroundColor gold
ArrowFontName Impact
ArrowColor #FF6655
ArrowFontColor #777777
}

() "Data Access" as DA

DA - [First Component]
[First Component] ..> () HTTP : use
HTTP - [Web Server] << Apache >>

@enduml
```

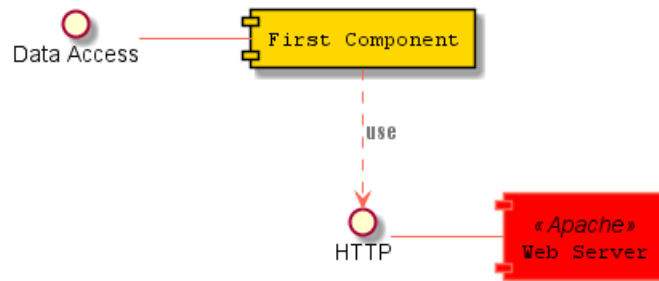

```
@startuml
[AA] <<static lib>>
[BB] <<shared lib>>
[CC] <<static lib>>

node node1
node node2 <<shared node>>
database Production

skinparam component {
backgroundColor<<static lib>> DarkKhaki
backgroundColor<<shared lib>> Green
}

skinparam node {
borderColor Green
backgroundColor Yellow
backgroundColor<<shared node>> Magenta
}
skinparam databaseBackgroundColor Aqua

@enduml
```



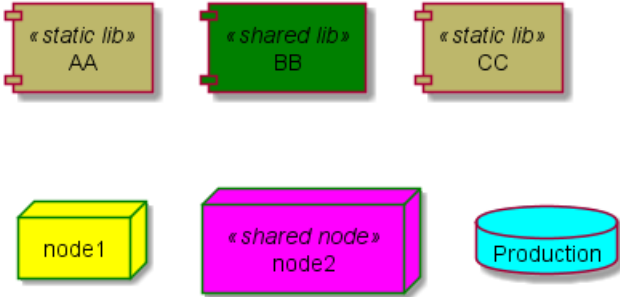

## 7 State Diagram

### 7.1 Simple State

You can use [\*] for the starting point and ending point of the state diagram.

Use --> for arrows.

```
@startuml
[*] --> State1
State1 --> [*]
State1 : this is a string
State1 : this is another string

State1 -> State2
State2 --> [*]

@enduml
```

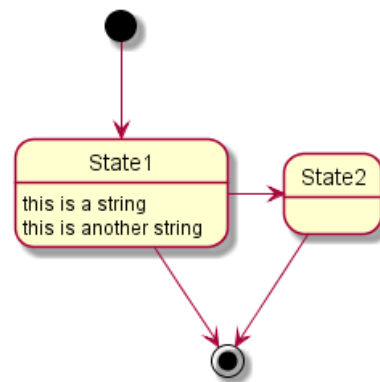

### 7.2 Composite state

A state can also be composite. You have to define it using the **state** keywords and brackets.

```
@startuml
scale 350 width
[*] --> NotShooting

state NotShooting {
[*] --> Idle
Idle --> Configuring : EvConfig
Configuring --> Idle : EvConfig
}

state Configuring {
[*] --> NewValueSelection
NewValueSelection --> NewValuePreview : EvNewValue
NewValuePreview --> NewValueSelection : EvNewValueRejected
NewValuePreview --> NewValueSelection : EvNewValueSaved
}

state NewValuePreview {
State1 -> State2
}

@enduml
```

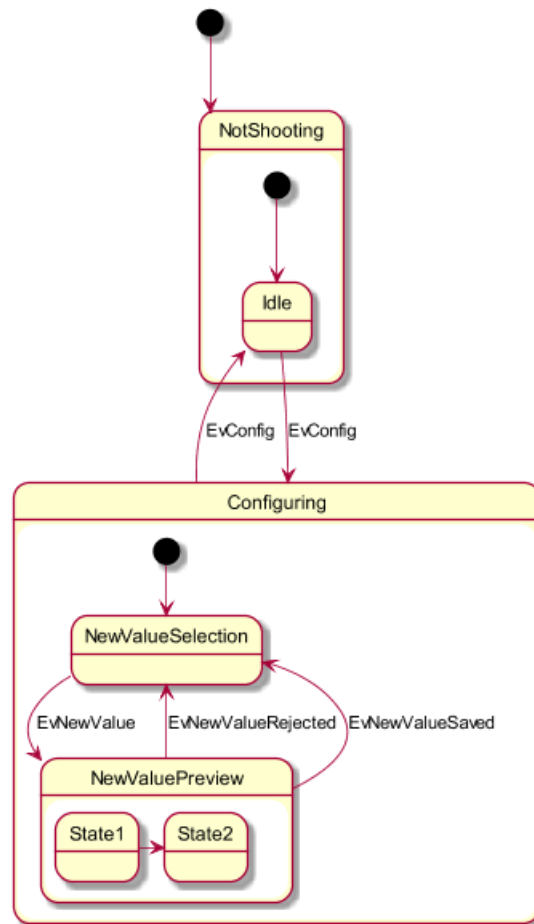

### 7.3 Long name

You can also use the `state` keyword to use long description for states.

```

@startuml
scale 600 width

[*] --> State1
State1 --> State2 : Succeeded
State1 --> [*] : Aborted
State2 --> State3 : Succeeded
State2 --> [*] : Aborted
state State3 {
state "Accumulate Enough Data\nLong State Name" as long1
long1 : Just a test
[*] --> long1
long1 --> long1 : New Data
long1 --> ProcessData : Enough Data
}
State3 --> State3 : Failed
State3 --> [*] : Succeeded / Save Result
State3 --> [*] : Aborted

@enduml
  
```

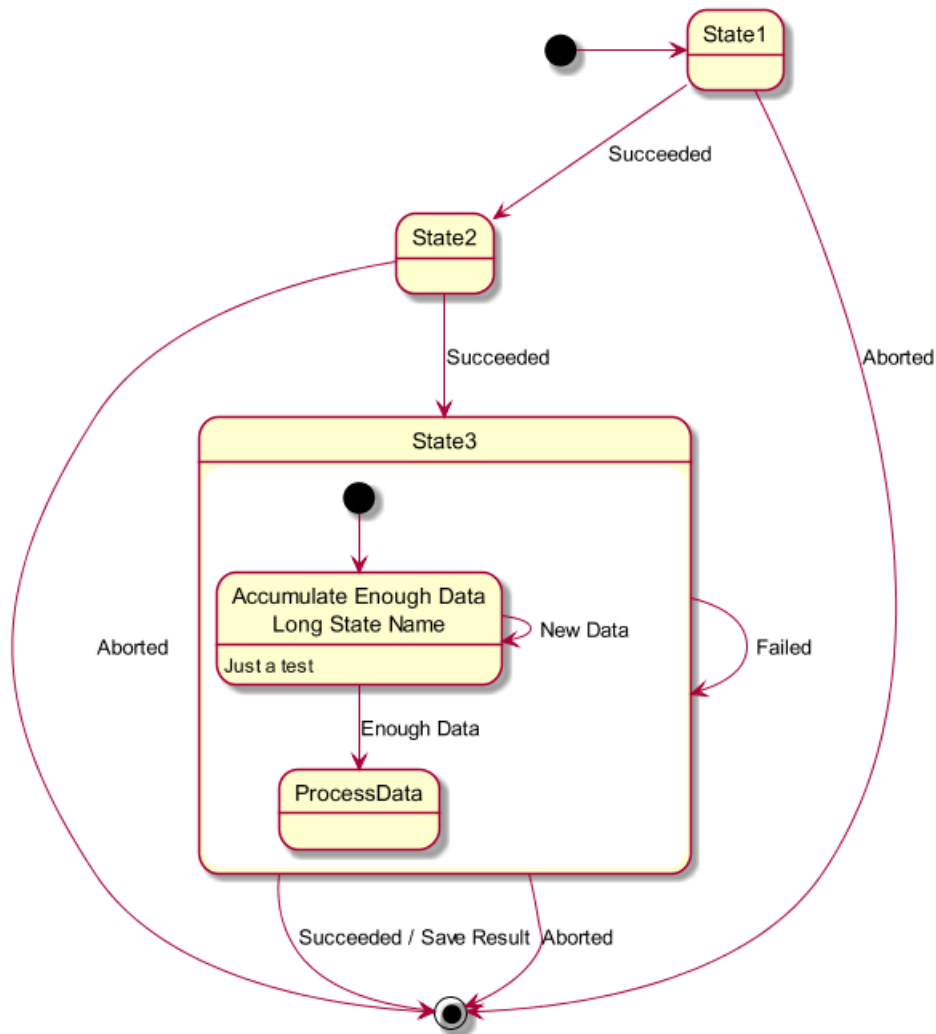

## 7.4 Concurrent state

You can define concurrent state into a composite state using either `--` or `||` symbol as separator.

```
@startuml
[*] --> Active

state Active {
  [*] -> NumLockOff
  NumLockOff --> NumLockOn : EvNumLockPressed
  NumLockOn --> NumLockOff : EvNumLockPressed
  --
  [*] -> CapsLockOff
  CapsLockOff --> CapsLockOn : EvCapsLockPressed
  CapsLockOn --> CapsLockOff : EvCapsLockPressed
  --
  [*] -> ScrollLockOff
  ScrollLockOff --> ScrollLockOn : EvCapsLockPressed
  ScrollLockOn --> ScrollLockOff : EvCapsLockPressed
}

@enduml
```

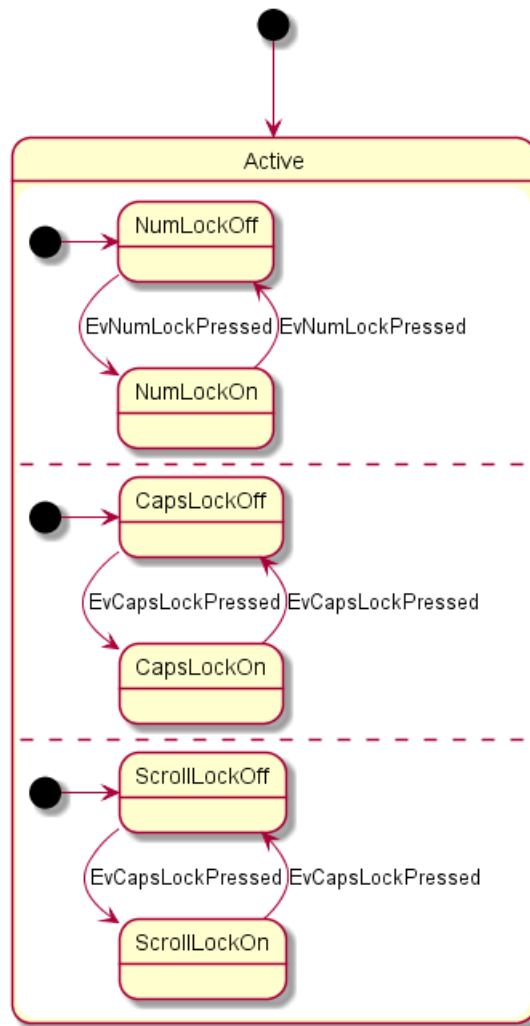

## 7.5 Arrow direction

You can use `->` for horizontal arrows. It is possible to force arrow's direction using the following syntax:

- `-down->` (default arrow)
- `-right->` or `->`
- `-left->`
- `-up->`

```
@startuml
```

```
[*] -up-> First
First -right-> Second
Second --> Third
Third -left-> Last
```

```
@enduml
```

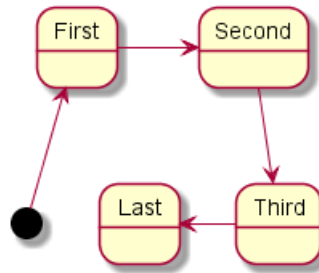

You can shorten the arrow by using only the first character of the direction (for example, `-d-` instead of `-down-`) or the two first characters (`-do-`).

Please note that you should not abuse this functionality : *Graphviz* gives usually good results without tweaking.

## 7.6 Note

You can also define notes using `note left of`, `note right of`, `note top of`, `note bottom of` keywords.

You can also define notes on several lines.

```

@startuml

[*] --> Active
Active --> Inactive

note left of Active : this is a short\nnote

note right of Inactive
A note can also
be defined on
several lines
end note

@enduml
  
```

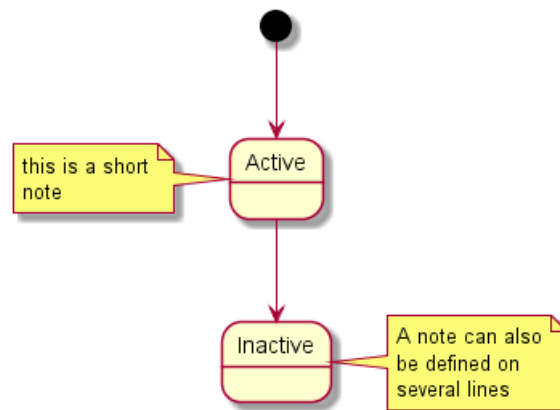

You can also have floating notes.

```

@startuml

state foo
note "This is a floating note" as N1

@enduml
  
```



## 7.7 More in notes

You can put notes on composite states.

```
@startuml
[*] --> NotShooting

state "Not Shooting State" as NotShooting {
state "Idle mode" as Idle
state "Configuring mode" as Configuring
[*] --> Idle
Idle --> Configuring : EvConfig
Configuring --> Idle : EvConfig
}

note right of NotShooting : This is a note on a composite state

@enduml
```

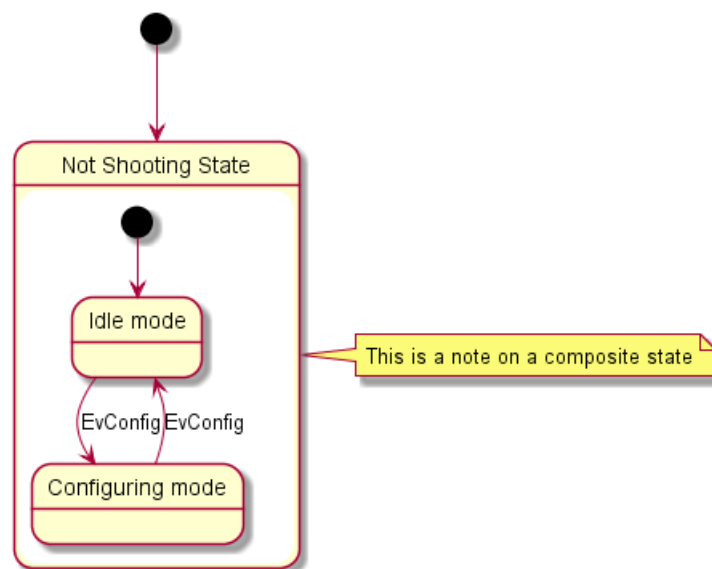

## 7.8 Skinparam

You can use the `skinparam` command to change colors and fonts for the drawing.

You can use this command :

- In the diagram definition, like any other commands,
- In an included file,
- In a configuration file, provided in the command line or the ANT task.

You can define specific color and fonts for stereotyped states.

```
@startuml
skinparam backgroundColor LightYellow
skinparam state {
StartColor MediumBlue
EndColor Red
BackgroundColor Peru
BackgroundColor<<Warning>> Olive
BorderColor Gray
FontName Impact
}

[*] --> NotShooting

state "Not Shooting State" as NotShooting {
```

```
state "Idle mode" as Idle <<Warning>>
state "Configuring mode" as Configuring
[*] --> Idle
Idle --> Configuring : EvConfig
Configuring --> Idle : EvConfig
}

NotShooting --> [*]
@enduml
```

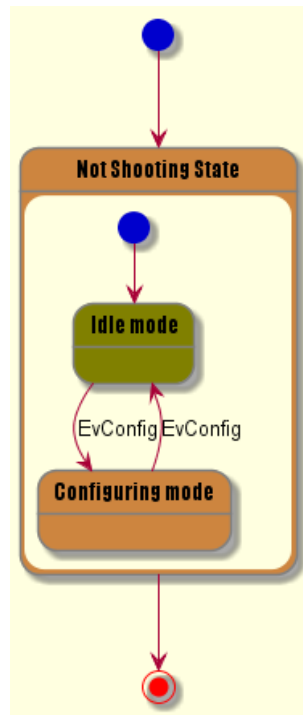



## 8 Object Diagram

### 8.1 Definition of objects

You define instance of objects using the `object` keywords.

```
@startuml
object firstObject
object "My Second Object" as o2
@enduml
```

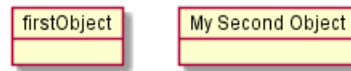

### 8.2 Relations between objects

Relations between objects are defined using the following symbols :

Extension	< --	
Composition	*--	
Aggregation	o--	

It is possible to replace `--` by `..` to have a dotted line.

Knowing those rules, it is possible to draw the following drawings.

It is possible to add a label on the relation, using `" : "`, followed by the text of the label.

For cardinality, you can use double-quotes `"` on each side of the relation.

```
@startuml
object Object01
object Object02
object Object03
object Object04
object Object05
object Object06
object Object07
object Object08

Object01 <|-- Object02
Object03 *-- Object04
Object05 o-- "4" Object06
Object07 .. Object08 : some labels
@enduml
```

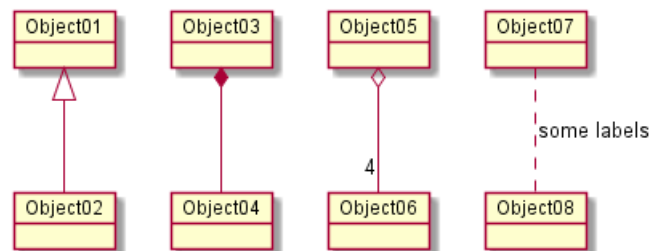

### 8.3 Adding fields

To declare fields, you can use the symbol `:"` followed by the field's name.

```
@startuml
object user

user : name = "Dummy"
user : id = 123

@enduml
```

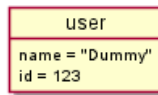

It is also possible to ground between brackets { all fields.

```
@startuml
object user {
name = "Dummy"
id = 123
}
@enduml
```

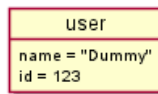

## 8.4 Common features with class diagrams

- Visibility
- Defines notes
- Use packages
- Title the diagram
- Skin the output
- Split the image

## 9 Common commands

### 9.1 Footer and header

You can use the commands `header` or `footer` to add a footer or a header on any generated diagram. You can optionally specify if you want a `center`, `left` or `right` footer/header, by adding a keyword.

As for title, it is possible to define a header or a footer on several lines.

It is also possible to put some HTML into the header or footer.

```
@startuml
Alice -> Bob: Authentication Request

header
<font color=red>Warning:</font>
Do not use in production.
endheader

center footer Generated for demonstration

@enduml
```

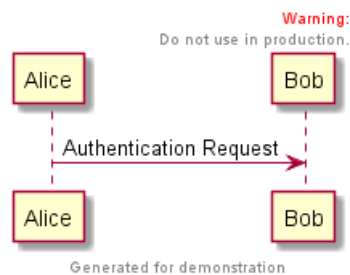

### 9.2 Zoom

You can use the `scale` command to zoom the generated image.

You can use either a number or a fraction to define the scale factor. You can also specify either width or height (in pixel). And you can also give both width and height : the image is scaled to fit inside the specified dimension.

- `scale 1.5`
- `scale 2/3`
- `scale 200 width`
- `scale 200 height`
- `scale 200*100`

```
@startuml
scale 180*90
Bob->Alice : hello
@enduml
```

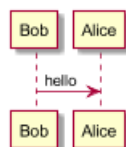

## 10 Salt

**Salt** is a subproject included in PlantUML that may help you to design graphical interface. You can use either `@startsalt` keyword, or `@startuml` followed by a line with `salt` keyword.

### 10.1 Basic widgets

A window must start and end with brackets. You can then define:

- Button using [ and ].
- Radio button using ( and ).
- Checkbox using [ and ].
- User text area using "

```
@startuml
salt
{
Just plain text
[This is my button]
() Unchecked radio
(X) Checked radio
[] Unchecked box
[X] Checked box
"Enter text here "
^This is a droplist^
}
@enduml
```

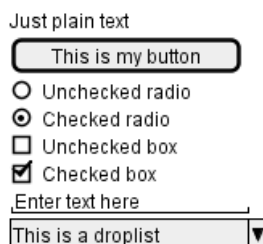

The goal of this tool is to discuss about simple and sample windows.

### 10.2 Using grid

A table is automatically created when you use an opening bracket {. And you have to use | to separate columns.

For example:

```
@startsalt
{
Login | "MyName" | "
Password | "****" | "
[Cancel] | [ OK ]
}
@endsalt
```

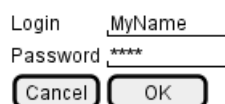

Just after the opening bracket, you can use a character to define if you want to draw lines or columns of the grid :

# To display all vertical and horizontal lines

! To display all vertical lines

- To display all horizontal lines

+ To display external lines

```
@startsalt
{+
Login   | "MyName   "
Password| "****     "
[Cancel]| [ OK    ]
}
@endsalt
```



### 10.3 Using separator

You can use several horizontal lines as separator.

```
@startsalt
{
Text1
..
"Some field"
==
Note on usage
~~
Another text
--
[Ok]
}
@endsalt
```

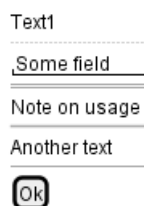

### 10.4 Tree widget

To have a Tree, you have to start with {T and to use + to denote hierarchy.

```
@startsalt
{
{T
+ World
++ America
+++ Canada
+++ USA
++++ New York
++++ Boston
+++ Mexico
++ Europe
+++ Italy
+++ Germany
```

```

++++ Berlin
++ Africa
}
}
@endsalt

```



## 10.5 Enclosing brackets

You can define subelements by opening a new opening bracket.

```

@startsalt
{
Name      | "          "
Modifiers: | { (X) public | () default | () private | () protected
[] abstract | [] final   | [] static }
Superclass: | { "java.lang.Object " | [Browse...] }
}
@endsalt

```

Name

Modifiers:  public  default  private  protected  
 abstract  final  static

Superclass:

## 10.6 Adding tabs

You can add tabs using {/ notation. Note that you can use HTML code to have bold text.

```

@startsalt
{+
{/ <b>General | Fullscreen | Behavior | Saving }
{
{ Open image in: | ^Smart Mode^ }
[X] Smooth images when zoomed
[X] Confirm image deletion
[ ] Show hidden images
}
[Close]
}
@endsalt

```

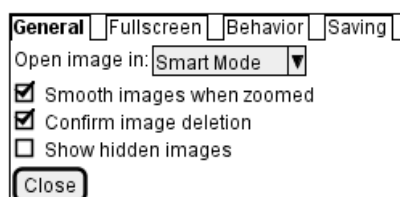

Tab could also be vertically oriented:

```

@startsalt
{+
{/ <b>General
Fullscreen
Behavior
Saving } |
{
{ Open image in: | ^Smart Mode^ }
[X] Smooth images when zoomed
[X] Confirm image deletion
[ ] Show hidden images
[Close]
}
}
@endsalt

```

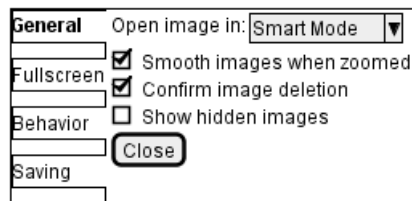

## 10.7 Using menu

You can add a menu by using `{*}` notation.

```

@startsalt
{+
{* File | Edit | Source | Refactor }
{/ General | Fullscreen | Behavior | Saving }
{
{ Open image in: | ^Smart Mode^ }
[X] Smooth images when zoomed
[X] Confirm image deletion
[ ] Show hidden images
}
[Close]
}
@endsalt

```

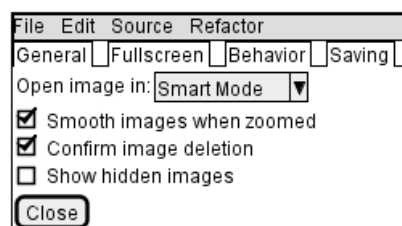

It is also possible to open a menu:

```

@startsalt
{+
{* File | Edit | Source | Refactor
Refactor | New | Open File | - | Close | Close All }
{/ General | Fullscreen | Behavior | Saving }
{
{ Open image in: | ^Smart Mode^ }
[X] Smooth images when zoomed
[X] Confirm image deletion
[ ] Show hidden images
}
[Close]
}
@endsalt

```

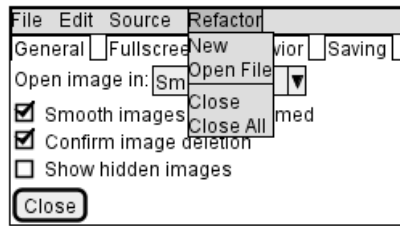

## 10.8 Advanced table

You can use two special notations for table :

- \* to indicate that a cell with span with left
- . to denotate an empty cell

```
@startsalt
{#
. | Column 2 | Column 3
Row header 1 | value 1 | value 2
Row header 2 | A long cell | *
}
@endsalt
```

	Column 2	Column 3
Row header 1	value 1	value 2
Row header 2	A long cell	



## 11 Creole

A light Creole engine have been integrated into PlantUML to have a standardized way of defining text style.

All diagrams are now supporting this syntax.

(Note that ascending compatibility with HTML syntax is preserved)

### 11.1 Emphasized text

```
@startuml
Alice -> Bob : hello --there--
... Some ~long delay~ ...
Bob -> Alice : ok
note left
This is bold
This is italics//
This is "monospaced"
This is --stroked--
This is underlined
This is ~waved~
end note
@enduml
```

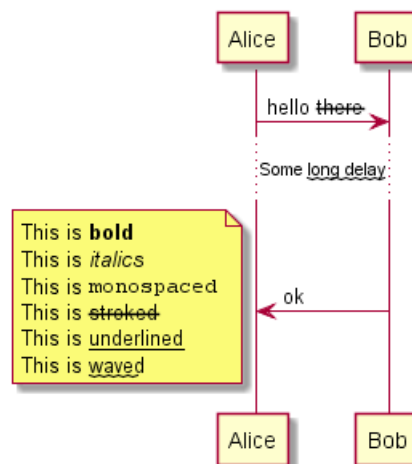

### 11.2 List

```
@startuml
object demo {
* Bullet list
* Second item
** Sub item
}

legend
# Numbered list
# Second item
## Sub item
## Another sub item
# Third item
end legend
@enduml
```

```
demo
* Bullet list
* Second item
** Sub item
```

```
1. Numbered list
2. Second item
   1. Sub item
   2. Another sub item
3. Third item
```

### 11.3 Escape character

You can use the tilde ~ to escape special creole characters.

```
@startuml
object demo {
This is not ~___underscored___.
This is not ~""monospaced"".
}
@enduml
```

```
demo
This is not ___underscored___.
This is not ""monospaced"".
```

### 11.4 Horizontal lines

```
@startuml
database DB1 as "
You can have horizontal line
----
Or double line
====
Or strong line
----
Or dotted line
..My title..
Enjoy!
"
note right
This is working also in notes
You can also add title in all these lines
==Title==
--Another title--
end note
@enduml
```

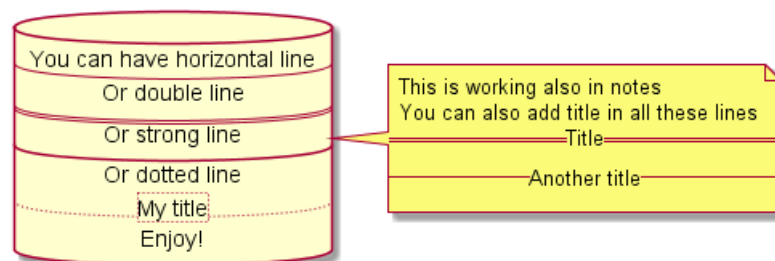

## 11.5 Headings

```
@startuml
usecase UC1 as "
= Extra-large heading
Some text
== Large heading
Other text
=== Medium heading
Information
....
==== Small heading"
@enduml
```



## 11.6 Legacy HTML

Some HTML tags are also working:

- `<b>` for bold text
- `<u>` or `<u:AAAAAA>` or `<u:colorName>` for underline
- `<i>` for italic
- `<s>` or `<s:AAAAAA>` or `<s:colorName>` for strike text
- `<w>` or `<w:AAAAAA>` or `<w:colorName>` for wave underline text `<!--`
- `<font color="AAAAAA">` or `<font color="colorName">` ->
- `<color:AAAAAA>` or `<color:colorName>`
- `<back:AAAAAA>` or `<back:colorName>` for background color
- `<size:nn>` to change font size
- `<img:file>` : the file must be accessible by the filesystem
- `<img:http://url>` : the URL must be available from the Internet

```
@startuml
:* You can change <color:red>text color</color>
* You can change <back:cadetblue>background color</back>
* You can change <size:18>size</size>
* You use <u>legacy</u> <b>HTML <i>tag</i></b>
* You use <u:red>color</u> <s:green>in HTML</s> <w:#0000FF>tag</w>
----
* Use image : <img:sourceforge.jpg>
;
@enduml
```

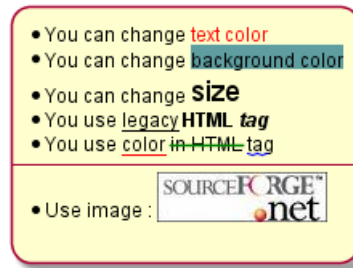

## 11.7 Table

```
@startuml
skinparam titleFontSize 14
title
Example of simple table
| = | = table | = header |
| a | table | row |
| b | table | row |
end title
[*] --> State1
@enduml
```

Example of simple table

	table	header
a	table	row
b	table	row

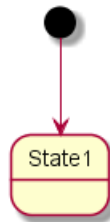

## 11.8 OpenIconic

OpenIconic is an very nice open source icon set. Those icons have been integrated into the creole parser, so you can use them out-of-the-box. You can use the following syntax: `<&ICON_NAME>`.

```
@startuml
title: <size:20>&heart>Use of OpenIconic</size>
class Wifi
note left
Click on &wifi>
end note
@enduml
```

### ♥Use of OpenIconic♥



The complete list is available on OpenIconic Website, or you can use the following special diagram:

```
@startuml
listopeniconic
@enduml
```

**List Open Iconic***Credit to*<https://useiconic.com/open>

↪ account-login	<b>B</b> bold	☰ collapse-down	👁 eye	☰ list	🔌 power-standby	⇄ transfer
↪ account-logout	⚡ bolt	⌵ collapse-left	👁 eyedropper	📍 location	🖨 print	🗑 trash
↶ action-redo	📖 book	⌵ collapse-right	📁 file	🔒 lock-locked	📁 project	📏 underline
↷ action-undo	📦 bookmark	☰ collapse-up	🔥 fire	🔒 lock-unlocked	⚡ pulse	⌵ vertical-align-bottom
☰ align-center	📦 box	⌵ command	🚩 flag	🔄 loop-circular	🧩 puzzle-piece	☰ vertical-align-center
☰ align-left	📁 briefcase	◻ comment-square	⚡ flash	◻ loop-square	❓ question-mark	☰ vertical-align-top
☰ align-right	£ british-pound	📄 compass	📁 folder	🔄 loop	🌧 rain	📺 video
🔍 aperture	🌐 browser	🔍 contrast	🍴 fork	🔍 magnifying-glass	✂ random	🔊 volume-high
↓ arrow-bottom	🖱 brush	☰ copywriting	🖱 fullscreen-enter	📍 map-marker	🔄 reload	🔊 volume-low
🕒 arrow-circle-bottom	🐛 bug	☰ credit-card	🖱 fullscreen-exit	🗺 map	↔️ resize-both	🔊 volume-off
🕒 arrow-circle-left	📡 bullhorn	✂ crop	🌐 globe	⏸ media-pause	⬆️ resize-height	⚠ warning
🕒 arrow-circle-right	📠 calculator	📊 dashboard	📊 graph	▶️ media-play	↔️ resize-width	📶 wifi
🕒 arrow-circle-top	📅 calendar	⬇️ data-transfer-download	☰ grid-four-up	🎵 media-record	📡 rss-alt	🔧 wrench
← arrow-left	📷 camera-slr	⬆️ data-transfer-upload	☰ grid-three-up	⏮ media-skip-backward	📡 rss	✂ x
→ arrow-right	▼ caret-bottom	🗑 delete	☰ grid-two-up	▶️ media-skip-forward	📄 script	¥ yen
↓ arrow-thick-bottom	⬅️ caret-left	📞 dial	💾 hard-drive	⏪ media-step-backward	📦 share-boxed	🔍 zoom-in
← arrow-thick-left	➡️ caret-right	📄 document	📁 header	▶️ media-step-forward	➦ share	🔍 zoom-out
→ arrow-thick-right	⬆️ caret-top	💵 dollar	🎧 headphones	⏹ media-stop	🛡 shield	
↑ arrow-top	🛒 cart	🔊 double-quote-sans-left	♥ heart	🏥 medical-cross	📶 signal	
🔊 audio-spectrum	💬 chat	🔊 double-quote-sans-right	🏠 home	☰ menu	🚧 signpost	
🔊 audio	✓ check	🔊 double-quote-serif-left	🖼 image	🎤 microphone	⬆️ sort-ascending	
🏷 badge	▼ chevron-bottom	🔊 double-quote-serif-right	📧 inbox	➖ minus	📄 sort-descending	
🚫 ban	⬅️ chevron-left	💧 droplet	∞ infinity	📺 monitor	📊 spreadsheet	
📊 bar-chart	➡️ chevron-right	🚫 eject	📍 info	🌙 moon	★ star	
🛒 basket	⬆️ chevron-top	🛗 elevator	🎩 italic	➡️ move	☀ sun	
🔋 battery-empty	🕒 circle-check	⋯ ellipses	☰ justify-center	🎵 musical-note	📱 tablet	
🔋 battery-full	⊗ circle-x	📁 envelope-closed	☰ justify-left	📎 paperclip	🏷 tag	
🥤 beaker	📁 clipboard	📁 envelope-open	☰ justify-right	🖊 pencil	🏷 tags	
🔔 bell	🕒 clock	📄 euro	🗝 key	👤 people	🎯 target	
📶 bluetooth	☁ cloud-download	☰ excerpt	📱 laptop	👤 person	📋 task	
	☁ cloud-upload	☰ expand-down	📱 layers	📱 phone	🖨 terminal	
	☁ cloud	⌵ expand-left	💡 lightbulb	📊 pie-chart	📄 text	
	☁ cloudy	⌵ expand-right	🔗 link-broken	📌 pin	👇 thumb-down	
	📄 code	☰ expand-up	🔗 link-intact	🎮 play-circle	👆 thumb-up	
	🔌 cog	🔗 external-link	☰ list-rich	➕ plus	🕒 timer	

## 11.9 Defining and using sprites

A *Sprite* is a small graphic element that can be used in diagrams.

In PlantUML, sprites are monochrome and can have either 4, 8 or 16 gray level.

To define a sprite, you have to use a hexadecimal digit between 0 and F per pixel.

Then you can use the sprite using <\$XXX> where XXX is the name of the sprite.

```
@startuml
sprite $foo1 {
FFFFFFFFFFFFFFFF
F0123456789ABCF
F0123456789ABCF
F0123456789ABCF
F0123456789ABCF
F0123456789ABCF
F0123456789ABCF
F0123456789ABCF
F0123456789ABCF
F0123456789ABCF
F0123456789ABCF
FFFFFFFFFFFFFFFF
}
Alice -> Bob : Testing <$foo1>
@enduml
```

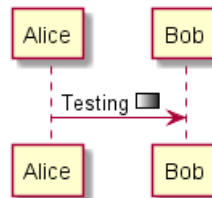

### 11.10 Encoding Sprite

To encode sprite, you can use the command line like:

```
java -jar plantuml.jar -encodesprite 16z foo.png
```

where `foo.png` is the image file you want to use (it will be converted to gray automatically).

After `-encodesprite`, you have to specify a format: 4, 8, 16, 4z, 8z or 16z.

The number indicates the gray level and the optional `z` is used to enable compression in sprite definition.

### 11.11 Importing Sprite

You can also launch the GUI to generate a sprite from an existing image.

Click in the menubar then on `File/Open Sprite Window`.

After copying an image into your clipboard, several possible definitions of the corresponding sprite will be displayed: you will just have to pick up the one you want.

### 11.12 Examples

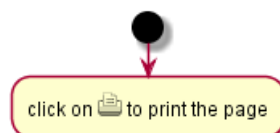

```

@startuml
sprite $printer [15x15/8z] N0tH3W0W208HxFz_kMAhj7lHWpa1XC716sz0Pq4MVPEWfBHIuxP3L6kbTcizR8tAhzaqFvXwvFfPE
start
:click on <$printer> to print the page;
@enduml

```

### Use of sprites (🖨️, ⚙️...)

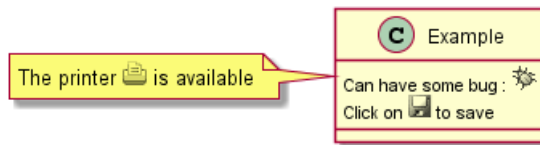

```

@startuml
sprite $bug [15x15/16z] PKzR2i0m2BFMi15p_FEjQEqB1z27aeqCqixa8S40T7C53cKpsHpaYPDJY_12MHM-BLRyywPhrrlw3qu
sprite $printer [15x15/8z] N0tH3W0W208HxFz_kMAhj7lHWpa1XC716sz0Pq4MVPEWfBHIuxP3L6kbTcizR8tAhzaqFvXwvFfPE
sprite $disk {
444445566677881
436000000009991
43600000000ACA1
53700000001A7A1
537000000012B8A1
53800000123B8A1
63800001233C9A1
634999AABBC99B1
744566778899AB1
7456AAAAA99AAB1
8566AFC228AABB1
8567AC8118BBBB1
867BD4433BBBBB1
39AAAAABBBBBBC1
}

title Use of sprites (<$printer>, <$bug>...)

class Example {
Can have some bug : <$bug>
Click on <$disk> to save
}

note left : The printer <$printer> is available

@enduml

```

## 12 Changing fonts and colors

### 12.1 Usage

You can change colors and font of the drawing using the `skinparam` command. Example:

```
skinparam backgroundColor yellow
```

You can use this command :

- In the diagram definition, like any other commands,
- In an included file (see *Preprocessing*),
- In a configuration file, provided in the command line or the ANT task.

### 12.2 Nested

To avoid repetition, it is possible to nest definition. So the following definition :

```
skinparam xxxxParam1 value1
skinparam xxxxParam2 value2
skinparam xxxxParam3 value3
skinparam xxxxParam4 value4
```

is strictly equivalent to:

```
skinparam xxxx {
  Param1 value1
  Param2 value2
  Param3 value3
  Param4 value4
}
```



## 12.3 Color

You can use either standard color name or RGB code.

Parameter name	Default Value	Color	Comment
backgroundColor	white		Background of the page
activityArrowColor	#A80036		Color of arrows in activity diagrams
activityBackgroundColor	#FEFECE		Background of activities
activityBorderColor	#A80036		Color of activity borders
activityStartColor	black		Starting circle in activity diagrams
activityEndColor	black		Ending circle in activity diagrams
activityBarColor	black		Synchronization bar in activity diagrams
usecaseArrowColor	#A80036		Color of arrows in usecase diagrams
usecaseActorBackgroundColor	#FEFECE		Head's color of actor in usecase diagrams
usecaseActorBorderColor	#A80036		Color of actor borders in usecase diagrams
usecaseBackgroundColor	#FEFECE		Background of usecases
usecaseBorderColor	#A80036		Color of usecase borders in usecase diagrams
classArrowColor	#A80036		Color of arrows in class diagrams
classBackgroundColor	#FEFECE		Background of classes/interface/enum in class diagrams
classBorderColor	#A80036		Borders of classes/interface/enum in class diagrams
packageBackgroundColor	#FEFECE		Background of packages in class diagrams
packageBorderColor	#A80036		Borders of packages in class diagrams
stereotypeCBackgroundColor	#ADD1B2		Background of class spots in class diagrams
stereotypeABackgroundColor	#A9DCDF		Background of abstract class spots in class diagrams
stereotypeIBackgroundColor	#B4A7E5		Background of interface spots in class diagrams
stereotypeEBackgroundColor	#EB937F		Background of enum spots in class diagrams
componentArrowColor	#A80036		Color of arrows in component diagrams
componentBackgroundColor	#FEFECE		Background of components
componentBorderColor	#A80036		Borders of components
componentInterfaceBackgroundColor	#FEFECE		Background of interface in component diagrams
componentInterfaceBorderColor	#A80036		Border of interface in component diagrams
noteBackgroundColor	#FBFB77		Background of notes
noteBorderColor	#A80036		Border of notes
stateBackgroundColor	#FEFECE		Background of states in state diagrams
stateBorderColor	#A80036		Border of states in state diagrams
stateArrowColor	#A80036		Colors of arrows in state diagrams
stateStartColor	black		Starting circle in state diagrams
stateEndColor	black		Ending circle in state diagrams
sequenceArrowColor	#A80036		Color of arrows in sequence diagrams
sequenceActorBackgroundColor	#FEFECE		Head's color of actor in sequence diagrams
sequenceActorBorderColor	#A80036		Border of actor in sequence diagrams
sequenceGroupBackgroundColor	#EEEEEE		Header color of alt/opt/loop in sequence diagrams
sequenceLifeLineBackgroundColor	white		Background of life line in sequence diagrams
sequenceLifeLineBorderColor	#A80036		Border of life line in sequence diagrams
sequenceParticipantBackgroundColor	#FEFECE		Background of participant in sequence diagrams
sequenceParticipantBorderColor	#A80036		Border of participant in sequence diagrams

## 12.4 Font color, name and size

You can change the font for the drawing using `xxxFontColor`, `xxxFontSize` and `xxxFontName` parameters.

Example:

```
skinparam classFontColor red
skinparam classFontSize 10
skinparam classFontName Apex
```

You can also change the default font for all fonts using `skinparam defaultFontName`.

Example:

```
skinparam defaultFontName Apex
```

Please note the fontname is highly system dependent, so do not over use it, if you look for portability.

Parameter Name	Default Value	Comment
activityFontColor activityFontSize activityFontStyle activityFontName	black 14 plain	Used for activity box
activityArrowFontColor activityArrowFontSize activityArrowFontStyle activityArrowFontName	black 13 plain	Used for text on arrows in activity diagrams
circledCharacterFontColor circledCharacterFontSize circledCharacterFontStyle circledCharacterFontName circledCharacterRadius	black 17 bold Courier 11	Used for text in circle for class, enum and others
classArrowFontColor classArrowFontSize classArrowFontStyle classArrowFontName	black 10 plain	Used for text on arrows in class diagrams
classAttributeFontColor classAttributeFontSize classAttributeIconSize classAttributeFontStyle classAttributeFontName	black 10 10 plain	Class attributes and methods
classFontColor classFontSize classFontStyle classFontName	black 12 plain	Used for classes name
classStereotypeFontColor classStereotypeFontSize classStereotypeFontStyle classStereotypeFontName	black 12 italic	Used for stereotype in classes
componentFontColor componentFontSize componentFontStyle componentFontName	black 14 plain	Used for components name
componentStereotypeFontColor componentStereotypeFontSize componentStereotypeFontStyle componentStereotypeFontName	black 14 italic	Used for stereotype in components

componentArrowFontColor componentArrowFontSize componentArrowFontStyle componentArrowFontName	black 13 plain	Used for text on arrows in component diagrams
noteFontColor noteFontSize noteFontStyle noteFontName	black 13 plain	Used for notes in all diagrams but sequence diagrams
packageFontColor packageFontSize packageFontStyle packageFontName	black 14 plain	Used for package and partition names
sequenceActorFontColor sequenceActorFontSize sequenceActorFontStyle sequenceActorFontName	black 13 plain	Used for actor in sequence diagrams
sequenceDividerFontColor sequenceDividerFontSize sequenceDividerFontStyle sequenceDividerFontName	black 13 bold	Used for text on dividers in sequence diagrams
sequenceArrowFontColor sequenceArrowFontSize sequenceArrowFontStyle sequenceArrowFontName	black 13 plain	Used for text on arrows in sequence diagrams
sequenceGroupingFontColor sequenceGroupingFontSize sequenceGroupingFontStyle sequenceGroupingFontName	black 11 plain	Used for text for "else" in sequence diagrams
sequenceGroupingHeaderFontColor sequenceGroupingHeaderFontSize sequenceGroupingHeaderFontStyle sequenceGroupingHeaderFontName	black 13 plain	Used for text for "alt/opt/loop" headers in sequence diagrams
sequenceParticipantFontColor sequenceParticipantFontSize sequenceParticipantFontStyle sequenceParticipantFontName	black 13 plain	Used for text on participant in sequence diagrams
sequenceTitleFontColor sequenceTitleFontSize sequenceTitleFontStyle sequenceTitleFontName	black 13 plain	Used for titles in sequence diagrams
titleFontColor titleFontSize titleFontStyle titleFontName	black 18 plain	Used for titles in all diagrams but sequence diagrams
stateFontColor stateFontSize stateFontStyle stateFontName	black 14 plain	Used for states in state diagrams
stateArrowFontColor stateArrowFontSize stateArrowFontStyle stateArrowFontName	black 13 plain	Used for text on arrows in state diagrams
stateAttributeFontColor stateAttributeFontSize stateAttributeFontStyle stateAttributeFontName	black 12 plain	Used for states description in state diagrams

usecaseFontColor usecaseFontSize usecaseFontStyle usecaseFontName	black 14 plain	Used for usecase labels in usecase diagrams
usecaseStereotypeFontColor usecaseStereotypeFontSize usecaseStereotypeFontStyle usecaseStereotypeFontName	black 14 italic	Used for stereotype in usecase
usecaseActorFontColor usecaseActorFontSize usecaseActorFontStyle usecaseActorFontName	black 14 plain	Used for actor labels in usecase diagrams
usecaseActorStereotypeFontColor usecaseActorStereotypeFontSize usecaseActorStereotypeFontStyle usecaseActorStereotypeFontName	black 14 italic	Used for stereotype for actor
usecaseArrowFontColor usecaseArrowFontSize usecaseArrowFontStyle usecaseArrowFontName	black 13 plain	Used for text on arrows in usecase diagrams
footerFontColor footerFontSize footerFontStyle footerFontName	black 10 plain	Used for footer
headerFontColor headerFontSize headerFontStyle headerFontName	black 10 plain	Used for header

## 12.5 Black and White

You can force the use of a black white output using the `skinparam monochrome true` command.

```
@startuml
skinparam monochrome true

actor User
participant "First Class" as A
participant "Second Class" as B
participant "Last Class" as C

User -> A: DoWork
activate A

A -> B: Create Request
activate B

B -> C: DoWork
activate C
C --> B: WorkDone
destroy C

B --> A: Request Created
deactivate B

A --> User: Done
deactivate A

@enduml
```

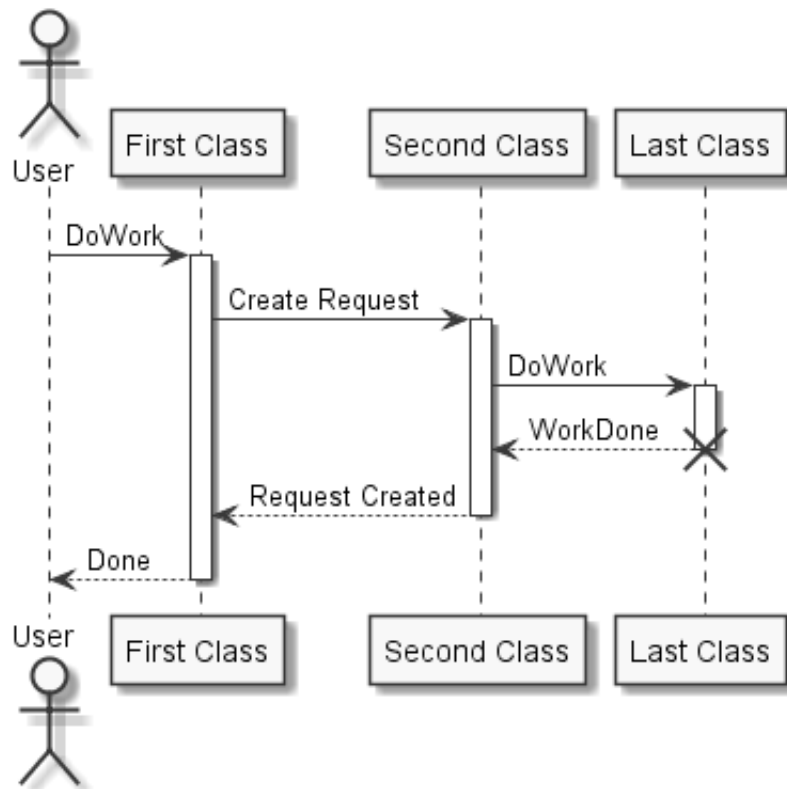

## 13 Preprocessing

Some minor preprocessing capabilities are included in **PlantUML**, and available for *all* diagrams. Those functionalities are very similar to the C language preprocessor, except that the special character (#) has been changed to the exclamation mark (!).

### 13.1 Including files

Use the `!include` directive to include file in your diagram.

Imagine you have the very same class that appears in many diagrams. Instead of duplicating the description of this class, you can define a file that contains the description.

```
@startuml
!include List.iuml
List <|.. ArrayList
@enduml
```

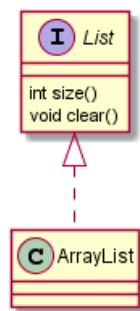

**File List.iuml:** interface List List : int size() List : void clear()

The file `List.iuml` can be included in many diagrams, and any modification in this file will change all diagrams that include it.

You can also put several `@startuml/@enduml` text block in an included file and then specify which block you want to include adding `!0` where `0` is the block number.

For example, if you use `!include foo.txt!1`, the second `@startuml/@enduml` block within `foo.txt` will be included.

### 13.2 Including URL

Use the `!includeurl` directive to include file from Internet/Intranet in your diagram.

You can also use `!includeurl http://someurl.com/mypath!0` to specify which `@startuml/@enduml` block from `http://someurl.com/mypath` you want to include. The `!0` notation denotes the first diagram.

### 13.3 Constant definition

You can define constant using the `!define` directive. As in C language, a constant name can only use alphanumeric and underscore characters, and cannot start with a digit.

```
@startuml
!define SEQUENCE (S,#AAAAAA) Database Sequence
!define TABLE (T,#FFAAAA) Database Table

class USER << TABLE >>
class ACCOUNT << TABLE >>
class UID << SEQUENCE >>
USER "1" -- "*" ACCOUNT
USER -> UID
@enduml
```

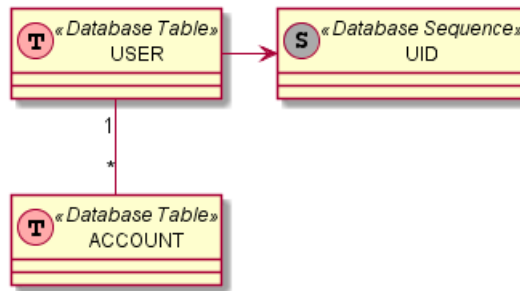

Of course, you can use the `!include` directive to define all your constants in a single file that you include in your diagram.

Constant can be undefined with the `!undef XXX` directive.

You can also specify constants within the command line, with the `-D` flags.

```
java -jar plantuml.jar -DTITLE="My title" atest1.txt
```

Note that the `-D` flag must be put after the `"-jar plantuml.jar"` section.

## 13.4 Macro definition

You can also define macro with arguments.

```
@startuml
!define module(x) component x <<module>>
module(ABC)
module(XYZ)
@enduml
```

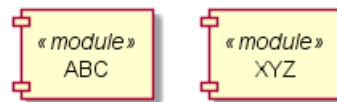

Macro can have several arguments.

```
@startuml
!define send(a,b,c) a->b : c
send(Alice, Bob, Hello)
send(Bob, Alice, ok)
@enduml
```



## 13.5 Macro on several lines

You can also define macro on several lines using `!definelong` and `!enddefinelong`.

```

@startuml
!define DOUBLE(x) x x
!definelong AUTHEN(x,y)
x -> y : DOUBLE(hello)
y -> x : ok
!enddefinelong

AUTHEN(Bob,Alice)
@enduml

```

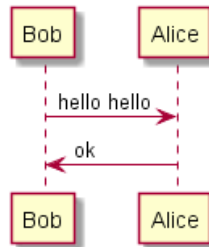

## 13.6 Conditions

You can use `!ifdef XXX` and `!endif` directives to have conditional drawings.

The lines between those two directives will be included only if the constant after the `!ifdef` directive has been defined before.

You can also provide a `!else` part which will be included if the constant has **not** been defined.

```

@startuml
!include ArrayList.iuml
@enduml

```

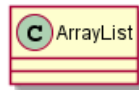

**File ArrayList.iuml:**

```

class ArrayList
!ifndef SHOW_METHODS
ArrayList : int size()
ArrayList : void clear()
!endif

```

You can then use the `!define` directive to activate the conditional part of the diagram.

```

@startuml
!define SHOW_METHODS
!include ArrayList.iuml
@enduml

```

```

@startuml
File already included R:\workspace_cs_d\plantu\sdoc.tex-en\ArrayList.iuml
Syntax Error?

```

You can also use the `!ifndef` directive that includes lines if the provided constant has NOT been defined.



## 13.7 Search path

You can specify the java property "plantuml.include.path" in the command line.

For example:

```
java -Dplantuml.include.path="c:/mydir" -jar plantuml.jar atest1.txt
```

Note the this -D option has to put before the -jar option. -D options after the -jar option will be used to define constants within plantuml preprocessor.

## 13.8 Advanced features

It is possible to append text to a macro argument using the ## syntax.

```
@startuml
!definelong COMP_TEXTGENCOMP(name)
[name] << Comp >>
interface Ifc << IfcType >> AS name##Ifc
name##Ifc - [name]
!enddefinelong
COMP_TEXTGENCOMP(dummy)
@enduml
```



A macro can be defined by another macro.

```
@startuml
!define DOUBLE(x) x x
!definelong AUTHEN(x,y)
x -> y : DOUBLE(hello)
y -> x : ok
!enddefinelong
AUTHEN(Bob,Alice)
@enduml
```

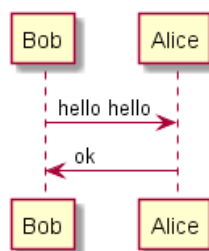

A macro can be polymorphic with argument count.

```
@startuml
!define module(x) component x <<module>>
!define module(x,y) component x as y <<module>>
module(foo)
module(bar, barcode)
@enduml
```

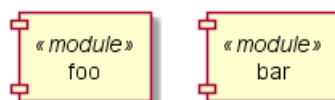

You can use system environment variable or constant definition when using include:

```
!include %windir%/test1.txt
!define PLANTUML_HOME /home/foo
!include PLANTUML_HOME/test1.txt
```

## 14 Internationalization

The PlantUML language use *letters* to define actor, usecase and so on. But *letters* are not only A-Z latin characters, it could be *any kind of letter from any language*.

```
@startuml
skinparam backgroundColor #EEEEBD
actor 使用者
participant "頭等艙" as A
participant "第二類" as B
participant "最後一堂課" as 別的東西
使用者 -> A: 完成這項工作
activate A
A -> B: 創建請求
activate B
B -> 別的東西: 創建請求
activate 別的東西
別的東西 --> B: 這項工作完成
destroy 別的東西
B --> A: 請求創建
deactivate B
A --> 使用者: 做完
deactivate A
@enduml
```

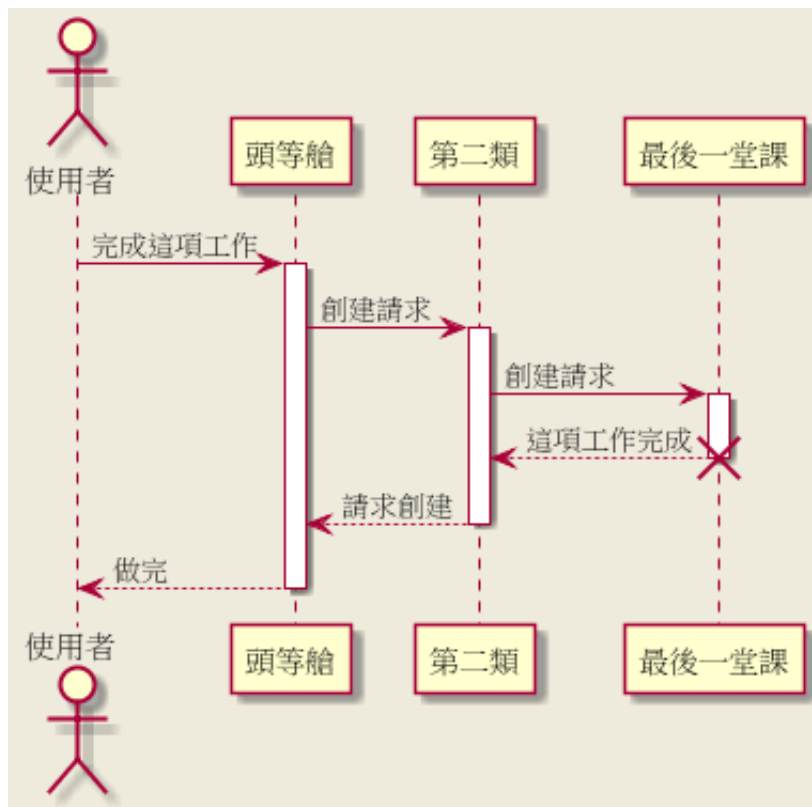

### 14.1 Charset

The default charset used when reading the text files containing the UML text description is system dependent. Normally, it should just be fine, but in some case, you may want to the use another charset. For example, with the command line:

```
java -jar plantuml.jar -charset UTF-8 files.txt
```

Or, with the ant task:

```
<target name="main">  
<plantuml dir="./src" charset="UTF-8" />  
</target>
```

Depending of your Java installation, the following charset should be available: ISO-8859-1, UTF-8, UTF-16BE, UTF-16LE, UTF-16.

## 15 Color Names

Here is the list of colors recognized by PlantUML. Note that color names are case insensitive.

	AliceBlue		GhostWhite		NavajoWhite
	AntiqueWhite		GoldenRod		Navy
	Aquamarine		Gold		OldLace
	Aqua		Gray		OliveDrab
	Azure		GreenYellow		Olive
	Beige		Green		OrangeRed
	Bisque		HoneyDew		Orange
	Black		HotPink		Orchid
	BlanchedAlmond		IndianRed		PaleGoldenRod
	BlueViolet		Indigo		PaleGreen
	Blue		Ivory		PaleTurquoise
	Brown		Khaki		PaleVioletRed
	BurlyWood		LavenderBlush		PapayaWhip
	CadetBlue		Lavender		PeachPuff
	Chartreuse		LawnGreen		Peru
	Chocolate		LemonChiffon		Pink
	Coral		LightBlue		Plum
	CornflowerBlue		LightCoral		PowderBlue
	Cornsilk		LightCyan		Purple
	Crimson		LightGoldenRodYellow		Red
	Cyan		LightGreen		RosyBrown
	DarkBlue		LightGray		RoyalBlue
	DarkCyan		LightPink		SaddleBrown
	DarkGoldenRod		LightSalmon		Salmon
	DarkGray		LightSeaGreen		SandyBrown
	DarkGreen		LightSkyBlue		SeaGreen
	DarkKhaki		LightSlateGray		SeaShell
	DarkMagenta		LightSteelBlue		Sienna
	DarkOliveGreen		LightYellow		Silver
	DarkOrchid		LimeGreen		SkyBlue
	DarkRed		Lime		SlateBlue
	DarkSalmon		Linen		SlateGray
	DarkSeaGreen		Magenta		Snow
	DarkSlateBlue		Maroon		SpringGreen
	DarkSlateGray		MediumAquaMarine		SteelBlue
	DarkTurquoise		MediumBlue		Tan
	DarkViolet		MediumOrchid		Teal
	Darkorange		MediumPurple		Thistle
	DeepPink		MediumSeaGreen		Tomato
	DeepSkyBlue		MediumSlateBlue		Turquoise
	DimGray		MediumSpringGreen		Violet
	DodgerBlue		MediumTurquoise		Wheat
	FireBrick		MediumVioletRed		WhiteSmoke
	FloralWhite		MidnightBlue		White
	ForestGreen		MintCream		YellowGreen
	Fuchsia		MistyRose		Yellow
	Gainsboro		Moccasin		

## Contents

<b>1</b>	<b>Sequence Diagram</b>	<b>1</b>
1.1	Basic examples . . . . .	1
1.2	Comments . . . . .	1
1.3	Declaring participant . . . . .	1
1.4	Use non-letters in participants . . . . .	2
1.5	Message to Self . . . . .	3
1.6	Change arrow style . . . . .	3
1.7	Change arrow color . . . . .	4
1.8	Message sequence numbering . . . . .	4
1.9	Title . . . . .	5
1.10	Legend the diagram . . . . .	6
1.11	Splitting diagrams . . . . .	6
1.12	Grouping message . . . . .	7
1.13	Notes on messages . . . . .	8
1.14	Some other notes . . . . .	9
1.15	Changing notes shape . . . . .	10
1.16	Creole and HTML . . . . .	10
1.17	Divider . . . . .	11
1.18	Reference . . . . .	12
1.19	Delay . . . . .	12
1.20	Space . . . . .	13
1.21	Lifeline Activation and Destruction . . . . .	13
1.22	Participant creation . . . . .	14
1.23	Incoming and outgoing messages . . . . .	15
1.24	Stereotypes and Spots . . . . .	16
1.25	More information on titles . . . . .	17
1.26	Participants encompass . . . . .	18
1.27	Removing Footer . . . . .	19
1.28	Skinparam . . . . .	19
<b>2</b>	<b>Use Case Diagram</b>	<b>21</b>
2.1	Usecases . . . . .	21
2.2	Actors . . . . .	21
2.3	Usecases description . . . . .	21
2.4	Basic example . . . . .	22
2.5	Extension . . . . .	23
2.6	Using notes . . . . .	23
2.7	Stereotypes . . . . .	24
2.8	Changing arrows direction . . . . .	24
2.9	Title the diagram . . . . .	26
2.10	Splitting diagrams . . . . .	26
2.11	Left to right direction . . . . .	26
2.12	Skinparam . . . . .	27
2.13	Complete example . . . . .	28

<b>3</b>	<b>Class Diagram</b>	<b>29</b>
3.1	Relations between classes . . . . .	29
3.2	Label on relations . . . . .	29
3.3	Adding methods . . . . .	31
3.4	Defining visibility . . . . .	32
3.5	Abstract and Static . . . . .	33
3.6	Advanced class body . . . . .	34
3.7	Notes and stereotypes . . . . .	35
3.8	More on notes . . . . .	36
3.9	Note on links . . . . .	37
3.10	Abstract class and interface . . . . .	38
3.11	Using non-letters . . . . .	39
3.12	Hide attributes, methods... . . . .	40
3.13	Hide classes . . . . .	41
3.14	Use generics . . . . .	41
3.15	Specific Spot . . . . .	41
3.16	Packages . . . . .	42
3.17	Packages style . . . . .	42
3.18	Namespaces . . . . .	43
3.19	Automatic namespace creation . . . . .	44
3.20	Lollipop interface . . . . .	45
3.21	Changing arrows direction . . . . .	45
3.22	Title the diagram . . . . .	46
3.23	Legend the diagram . . . . .	46
3.24	Association classes . . . . .	47
3.25	Skinparam . . . . .	48
3.26	Skinned Stereotypes . . . . .	48
3.27	Color gradient . . . . .	49
3.28	Splitting large files . . . . .	50
<b>4</b>	<b>Activity Diagram</b>	<b>52</b>
4.1	Simple Activity . . . . .	52
4.2	Label on arrows . . . . .	52
4.3	Changing arrow direction . . . . .	52
4.4	Branches . . . . .	53
4.5	More on Branches . . . . .	54
4.6	Synchronization . . . . .	55
4.7	Long activity description . . . . .	56
4.8	Notes . . . . .	56
4.9	Partition . . . . .	57
4.10	Title the diagram . . . . .	58
4.11	Skinparam . . . . .	59
4.12	Octagon . . . . .	59
4.13	Complete example . . . . .	60

<b>5</b>	<b>Activity Diagram (beta)</b>	<b>63</b>
5.1	Simple Activity . . . . .	63
5.2	Start/Stop . . . . .	63
5.3	Conditional . . . . .	64
5.4	Repeat loop . . . . .	65
5.5	While loop . . . . .	65
5.6	Parallel processing . . . . .	66
5.7	Notes . . . . .	66
5.8	Title Legend . . . . .	67
5.9	Colors . . . . .	68
5.10	Arrows . . . . .	68
5.11	Grouping . . . . .	69
5.12	Swimlanes . . . . .	70
5.13	Detach . . . . .	70
5.14	SDL . . . . .	71
5.15	Complete example . . . . .	72
<b>6</b>	<b>Component Diagram</b>	<b>74</b>
6.1	Components . . . . .	74
6.2	Interfaces . . . . .	74
6.3	Basic example . . . . .	74
6.4	Using notes . . . . .	75
6.5	Grouping Components . . . . .	75
6.6	Changing arrows direction . . . . .	77
6.7	Title the diagram . . . . .	78
6.8	Use UML2 notation . . . . .	78
6.9	Individual colors . . . . .	78
6.10	Skinparam . . . . .	79
<b>7</b>	<b>State Diagram</b>	<b>81</b>
7.1	Simple State . . . . .	81
7.2	Composite state . . . . .	81
7.3	Long name . . . . .	82
7.4	Concurrent state . . . . .	83
7.5	Arrow direction . . . . .	84
7.6	Note . . . . .	85
7.7	More in notes . . . . .	86
7.8	Skinparam . . . . .	86
<b>8</b>	<b>Object Diagram</b>	<b>88</b>
8.1	Definition of objects . . . . .	88
8.2	Relations between objects . . . . .	88
8.3	Adding fields . . . . .	88
8.4	Common features with class diagrams . . . . .	89



<b>9</b>	<b>Common commands</b>	<b>90</b>
9.1	Footer and header . . . . .	90
9.2	Zoom . . . . .	90
<b>10</b>	<b>Salt</b>	<b>91</b>
10.1	Basic widgets . . . . .	91
10.2	Using grid . . . . .	91
10.3	Using separator . . . . .	92
10.4	Tree widget . . . . .	92
10.5	Enclosing brackets . . . . .	93
10.6	Adding tabs . . . . .	93
10.7	Using menu . . . . .	94
10.8	Advanced table . . . . .	95
<b>11</b>	<b>Creole</b>	<b>96</b>
11.1	Emphasized text . . . . .	96
11.2	List . . . . .	96
11.3	Escape character . . . . .	97
11.4	Horizontal lines . . . . .	97
11.5	Headings . . . . .	98
11.6	Legacy HTML . . . . .	98
11.7	Table . . . . .	99
11.8	OpenIconic . . . . .	99
11.9	Defining and using sprites . . . . .	101
11.10	Encoding Sprite . . . . .	101
11.11	Importing Sprite . . . . .	101
11.12	Examples . . . . .	101
<b>12</b>	<b>Changing fonts and colors</b>	<b>103</b>
12.1	Usage . . . . .	103
12.2	Nested . . . . .	103
12.3	Color . . . . .	104
12.4	Font color, name and size . . . . .	105
12.5	Black and White . . . . .	108
<b>13</b>	<b>Preprocessing</b>	<b>109</b>
13.1	Including files . . . . .	109
13.2	Including URL . . . . .	109
13.3	Constant definition . . . . .	109
13.4	Macro definition . . . . .	110
13.5	Macro on several lines . . . . .	110
13.6	Conditions . . . . .	111
13.7	Search path . . . . .	112
13.8	Advanced features . . . . .	112
<b>14</b>	<b>Internationalization</b>	<b>114</b>
14.1	Charset . . . . .	114
<b>15</b>	<b>Color Names</b>	<b>116</b>